



PRODUCT

INFORMATION

DIGITAL SALES



SEATING



TABLES



KIDS



STORAGE & ACCESSORIES



A modern office interior featuring a prominent red brick wall on the left and black curtains on the right. A long, white desk is positioned in the foreground, with a grey office chair behind it. On the desk, there are blue storage boxes, a small blue device, and a silver lamp. The overall aesthetic is clean and professional.

DIGITAL

SALES

CROSSOVER
consultants



TAG: WS-1

BACK ◀

GEBESA – FLEXIBLE SOLUTION DESKING

MODEL NO: TBC
W 78" x D 36" x H 29"
QTY 1



PRODUCT DETAILS

MANUFACTURER: GEBESA

PRODUCT: FLEXIBLE SOLUTION DESKING

DESCRIPTION: DESK WITH DOUBLE LOOP LEG

MODESTY PANEL 52"X12" SOLID METAL, EMBEDDED WIRE MANAGEMENT SYSTEM INCLUDING GROMMET PASS THROUGH MOBILE PEDESTAL

FINISHES:

TOP: KRONOSPAN LATTE

EDGE: OSTERMANN

FRAME: POWDER COATED METAL BLACK

APPROVAL: _____

SIGNATURE: _____

CROSSOVER
consultants



TAG: PS-1

BACK ◀

GEBESA – POWERED SPINE

MODEL NO: TBC

W 42 x H 45"

QTY 1

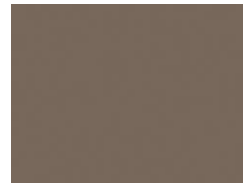

PRODUCT DETAILS

MANUFACTURER: GEBESA

PRODUCT: FLEXIBLE SOLUTION DESKING

DESCRIPTION: 42"W x 45"H POWERED PANEL WITH ELECTRIC & DATA TABLES TO CONNECT TO SPINE WALL VIA BRACKET. EASILY RE-CONFIGURABLE

FINISHES:

FABRIC: TBC

FRAME: POWDER COATED METAL BLACK

APPROVAL: _____

SIGNATURE: _____

CROSSOVER
consultants



TAG: WS-2

BACK ◀

BERNHARDT – MEDIA WALL

MODEL NO: TBC

W 72" x D 36" x H 29" (MEDIA WALL H 70.25")

QTY 1 OR 2 SIDED



PRODUCT DETAILS

MANUFACTURER: BERNHARDT

PRODUCT: PARALLAX/MEDIA WALL

DESCRIPTION: BACK PAINTED GLASS TOP, PARALLAX LEGS. WOOD PANELED MEDIA WALL. DESIGNED WITH OR WITHOUT TV INFRASTRUCTURE. SINGLE OR DOUBLE SIDED. GROMMET FOR CABLE PASS THROUGH. POWER TELEDAPT FOR CONVENIENCE CHARGING.

OPTIONAL MOBILE PEDESTAL

FINISHES:

TOP: BACK PAINTED GLASS, BLACK

EDGE: RADIUS KNIFE EDGE

FRAME: BLACK OAK, POLISHED CHROME

APPROVAL: _____

SIGNATURE: _____

CROSSOVER
consultants



TAG: CC-DS-1

BACK ◀

WALTER KNOLL – DIGITAL DISPLAY

MODEL NO: TBC
W 72" x D 36" x H 29"
QTY 1 OR 2 SIDED



PRODUCT DETAILS

MANUFACTURER: WALTER KNOLL
PRODUCT: MEDIA X-STELE MOBILE OR FIXED
DESCRIPTION: MEDIA WALL SUPPORTING TVS 55-85".
COMPARTMENT IN THE FRONT FOR MEDIA PLAYER, CABLING MANAGEMENT
HEIGHT ADJUSTABILITY FEATURE

FINISHES:
TOP & BASE: BLACK

APPROVAL: _____

SIGNATURE: _____

CROSSOVER
consultants

SEATING





TAG: CH2

BACK ◀

WILKHAHN MODUS COMPACT TASK CHAIR

MODEL NO: 275/7

W 25.25" x D 24" x H 35.75"-40" x SH 16.5" – 20.75"

QTY 1

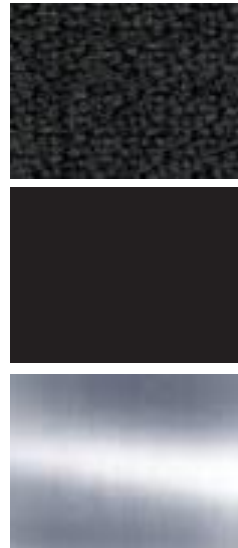

PRODUCT DETAILS

MANUFACTURER: WILKHAHN

PRODUCT: MODUS COMPACT CHAIR

DESCRIPTION: TASK CHAIR WITH MESH BACK POLISHED ALUMINUM OR BLACK BASE OPTION, MEDIUM HEIGHT BACKREST WITH SEAT CUSHION, AUTOMATIC SYNCHRO-ADJUSTMENT AND TENSION CONTROL FIXED ARMREST

FINISHES:

SEAT/BACK: SEAT COVER CLASS FABIRC 54/PITCH 25/ ANTHRACITE/ BLACK, BACK: SEMI-TRANSPARENT/ BLACK

FRAME, CASTERS, & ARM CAP: POLISHED

BASE: POLISHED ALUMINUM OR BLACK OPTION

APPROVAL: _____

SIGNATURE: _____

CROSSOVER
consultants



TAG: CH2-C

BACK ◀

DAVIS LINQ- FULLY UPHOLSTERED TASK CHAIR

MODEL NO: LINQ- LQ2000

W 41.75" x D 22.5" x H 38" x SH 17.75" – 21.5"

QTY 1



PRODUCT DETAILS

MANUFACTURER: DAVIS

PRODUCT: LINQ FULLY UPHOLSTERED CHAIR

DESCRIPTION: TASK CHAIR FULLY UPHOLSTERED WITH CENTER BASE AND POLISHED ALUMINUM BASE

FINISHES:

SEAT/BACK: ULTRAFABRICS/ ULTRALEATHER/ SCHOONER OR RAVEN WING

EXTERIOR BACK: LINQ UPHOLSTERY/ CHARCOAL

FRAME, CASTERS, & ARM CAP: BLACK

BASE: POLISHED ALUMINUM OR BLACK

APPROVAL: _____

SIGNATURE: _____

CROSSOVER
consultants



TAG: CH2-D

BACK ◀

DAVIS LINQ- KNIT BACK TASK CHAIR

MODEL NO: LINQ- LQ1500

W 41.75" x D 22.5" x H 38" x SH 17.75" – 21.5"

QTY 1



PRODUCT DETAILS

MANUFACTURER: DAVIS

PRODUCT: LINQ KNIT BACK TASK CHAIR

DESCRIPTION: TASK CHAIR KNIT BACK WITH CENTER BASE AND POLISHED ALUMINUM/ CASTER BASE

FINISHES:

SEAT/BACK: ULTRAFABRICS/ ULTRALEATHER/ SCHOONER OR RAVEN WING, KNIT BACK

EXTERIOR BACK: LINQ UPHOLSTERY/ CHARCOAL

FRAME, CASTERS, & ARM CAP: BLACK

BASE: POLISHED ALUMINUM OR BLACK

APPROVAL: _____

SIGNATURE: _____

CROSSOVER
consultants



TAG: CH8-A

BACK ◀

SOURCE JUMP HIGH FOUR SWIVEL CHAIR

MODEL NO: 280-H4C

W 27" x D 27" x H 31.5" x SH 19"

QTY 1



PRODUCT DETAILS

MANUFACTURER: SOURCE INTERNATIONAL

PRODUCT: JUMP HIGH FOUR SWIVEL CHAIR

DESCRIPTION: TASK CHAIR FAUX LEATHER SEAT AND BACK WITH CHROME BASE AND CASTERS

FINISHES:

SEAT/BACK: FAUX BLACK LEATHER

BASE AND CASTERS: BLACK

APPROVAL: _____

SIGNATURE: _____

CROSSOVER
consultants



TAG: CH8-B

BACK ◀

GLOBAL FACTOR TASK CHAIR

MODEL NO: 5540

W 26.5" x D 24" x H 39-43"

QTY 1

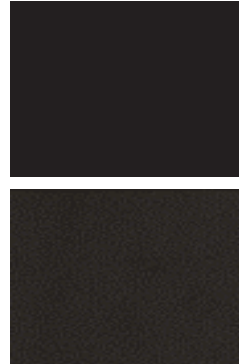

PRODUCT DETAILS

MANUFACTURER: GLOBAL FURNITURE GROUP

PRODUCT: FACTOR TASK CHAIR

DESCRIPTION: TASK CHAIR MESH BACK WITH CENTER BASE AND BLACK FRAME

FINISHES:

SEAT: ALLANTE FREE INK

BACK: BLACK MESH

FRAME, CASTERS, & ARM CAP: BLACK

APPROVAL: _____

SIGNATURE: _____

CROSSOVER
consultants



TAG:CH8-C

BACK ◀

GINKGO WITH WHEELS

MODEL NO: GKCN-100-WW
W27 3/8" x D25 3/4" x H37-40" x SH18 1/4-22 1/8"
QTY 1

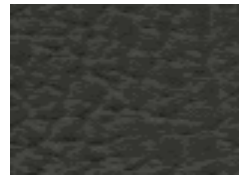

PRODUCT DETAILS

MANUFACTURER: DAVIS

PRODUCT: GINKGO CONFERENCE CHAIR WITH WHEELS

DESCRIPTION: GINKGO MID BACK , FIVE STAR CASTER SWIVEL BASE, LIGHT WALNUT SHELL

FINISHES:

SEAT: DESIGNTEX SORANO KEYSTONE (GRADE C), FELT MELANGE CONSTANT OR GREIGE (GRADE I)

BACK: LIGHT WALNUT

BASE: POLISHED ALUMINUM/BLACK

APPROVAL: _____

SIGNATURE: _____

CROSSOVER
consultants



TAG: CH8-D

BACK ◀

WILKHAHN OCCO WITH WHEELS

MODEL NO: 222/41

W 26" x D 22" x H 32 1/4" x SH 17 3/8"

QTY 1



PRODUCT DETAILS

MANUFACTURER: WILKHAHN

PRODUCT: OCCO CHAIR WITH WHEELS

DESCRIPTION: WILKHAHN OCCO FIVE STAR SWIVEL CHAIR ON CASTERS

FINISHES:

SEAT: KVADRAT STEELCUT TRIO 91/383

BACK/ARMS: BLACK POLY SHELL

FRAME: MATTE BLACK POWDER COAT

APPROVAL: _____

SIGNATURE: _____

CROSSOVER
consultants



TAG: CH8-E

BACK ◀

FRIANT IGNITE TASK CHAIR

MODEL NO: FD00253

W 26" - 28" x D 18.5" x H 39" - 42" x SH 17" - 19.5"

QTY 1



PRODUCT DETAILS

MANUFACTURER: FRIANT

PRODUCT: IGNITE TASK CHAIR

DESCRIPTION: IGNITE TASK CHAIR, HEIGHT ADJUSTABLE 3D PADDED ARMRESTS, MESH BACK, ADJUSTABLE LUMBAR SUPPORT, 5 STAR PLASTIC BASE WITH CASTERS, SYNCHRONOUS MECHANISM WITH 4 LOCK POSITION, SEAT SLIDER, PNEUMATIC LIFT

FINISHES:

SEAT: BLACK

BACK: MESH BLACK

FRAME: BLACK

APPROVAL: _____

SIGNATURE: _____



TAG: CH8-F

BACK ◀

9 TO 5 NEO LITE

MODEL NO: 3150

W 25" x D 26" x H 38" - 43" x SH 18" - 23"

QTY 1



PRODUCT DETAILS

MANUFACTURER: 9TO5

PRODUCT: NEO LITE 3150 TASK CHAIR

DESCRIPTION: TASK CHAIR WITH MESH BACK, ADJUSTABLE LUMBAR, 5-STAR BASE WITH CASTERS

FINISHES:

SEAT: HARBOR ABYSS

BACK: BLACK MESH

FRAME, CASTERS, & ARM CAP: BLACK

APPROVAL: _____

SIGNATURE: _____

CROSSOVER
consultants



TAG: CH4

BACK ◀

WILKHAHN MODUS BASIC STOOL

MODEL NO: 263/1

W 25.25" x D 24" x H 43.75" – 48.75" x SH 24.5" - 29.5"

QTY 1

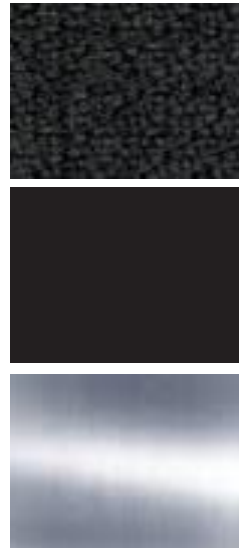

PRODUCT DETAILS

MANUFACTURER: WILKHAHN

PRODUCT: MODUS BASIC STOOL

DESCRIPTION: COUNTER STOOL WITH FIXED ARMRESTS AND POLISHED ALUMINUM OR COATED BLACK BASE

FINISHES:

SEAT/BACK: PITCH 54/25

ARMS: BLACK POLYMER

BASE: POLISHED ALUMINUM OR BLACK

APPROVAL: _____

SIGNATURE: _____

CROSSOVER
consultants



TAG: CH4-B

BACK ◀

DAVIS LINQ STOOL-FULLY UPHOLSTERED STOOL

MODEL NO: XLQ-2000-PA

W 23" x D 22.5" x H 46" - 49.75" x SH 26.25" - 30"

QTY 1



PRODUCT DETAILS

MANUFACTURER: DAVIS

PRODUCT: LINQ STOOL

DESCRIPTION: TASK STOOL FULLY UPHOLDSTERED WITH BLACK CASTER AND ARM CAP, POLISHED ALUMINUM OR BLACK BASE OPTION

FINISHES:

SEAT: ULTRALEATHER 291 SCHOONER OR RAVEN WING

BACK: BLACK RUNNER

FRAME & ARM CAP: BLACK

BASE: POLISHED ALUMINUM OR BLACK

APPROVAL: _____

SIGNATURE: _____

CROSSOVER
consultants



TAG: CH4-C

BACK ◀

DAVIS LINQ STOOL-KNIT BACK STOOL

MODEL NO: XLQ-1500

W 23" x D 22.5" x H 46" - 49.75" x SH 26.25" - 30"

QTY 1



PRODUCT DETAILS

MANUFACTURER: DAVIS

PRODUCT: LINQ STOOL

DESCRIPTION: TASK STOOL WITH MESH BACK AND POLISHED ALUMINUM OR BLACK BASE

FINISHES:

SEAT: ULTRAFABRICS/ULTRALEATHER/SCHOONER OR RAVEN WING, KNIT BACK

BACK: BLACK MESH

FRAME & ARM CAP: BLACK

BASE/CASTERS: POLISHED ALUMINUM OR BLACK

APPROVAL: _____

SIGNATURE: _____

CROSSOVER
consultants



TAG: CH3-C

BACK ◀

ANDREU WORLD FLEX HIGH BACK

MODEL NO: SI1621

W 20.75" x D 20.5" x H 32" x SH 18"

QTY 1



PRODUCT DETAILS

MANUFACTURER: ANDREU WORLD

PRODUCT: FLEX HIGH BACK CHAIR

DESCRIPTION: STACKABLE CUSTOMER CHAIR, FULLY UPHOLSTERED WITH VALENCIA SEAT/BACK AND SLED ALUMINUM BASE

FINISHES:

SEAT: VALENCIA TAUPE (107-0034) WITH PARALLEL STITCHING

BASE: ALUMINUM

APPROVAL: _____

SIGNATURE: _____



TAG: CH3-F

BACK ◀

SOURCE JUMP CHAIR

MODEL NO: 284-SL-B6-NG
W 22.5" x D 20.5" x H 32.25" x SH 17.75"
QTY 1



PRODUCT DETAILS

MANUFACTURER: SOURCE

PRODUCT: JUMP CHAIR

DESCRIPTION: CUSTOMER CHAIR WITH FAUX BLACK LEATHER SEAT/BACK AND CROME BASE

FINISHES:

SEAT AND SHELL: FAUX MAHARAM LARIAT, COLOR BLACK 440401

BASE: CHROME

APPROVAL: _____

SIGNATURE: _____



TAG: CH3-B

BACK ◀

WALTER KNOLL LIZ CHAIR

MODEL NO: 1300

W 21" x D 23" x H 32" x SH 19"

QTY 1



PRODUCT DETAILS

MANUFACTURER: WALTER KNOLL

PRODUCT: LIZ CHAIR

DESCRIPTION: LOW BACK CHAIR WITHOUT ARMRESTS

FINISHES:

SEAT: LUCIA MOONLIGHT/CANVAS TIMBER/CANVAS SISAL

FRAME: BLACK MATTE OR BRONZE MATTE

APPROVAL: _____

SIGNATURE: _____



TAG: CH3-D

BACK ◀

WILKHAHN OCCO WITH 4-STAR BASE

MODEL NO: 222/31

W 22.5" x D 22" x H 32 5/8" x SH 17 3/8"

QTY 1



PRODUCT DETAILS

MANUFACTURER: WILKHAHN

PRODUCT: OCCO WITH 4-STAR BASE FRAME

DESCRIPTION: VISITOR CHAIR, SWIVEL MOUNTED WITH BLACK FRAME

FINISHES:

SEAT: KVADRAT STEELCUT TRIO 91/383

BACK/ARMS: BLACK POLY SHELL

FRAME: MATTE BLACK POWDER COAT

APPROVAL: _____

SIGNATURE: _____

CROSSOVER
consultants



TAG: CH3-E

BACK ◀

WALTER KNOLL SHERU 4-STAR SWIVEL MODEL

MODEL NO: 1436

W 27.25" x D 24" x H 33" x SH 18.5"

QTY 1



PRODUCT DETAILS

MANUFACTURER: WALTER KNOLL

PRODUCT: SHERU 4-STAR BASE

DESCRIPTION: CHAIR WITHOUT ARMRESTS, 4-STAR SWIVEL BASE, UPHOLSTERED FRONT AND BACK IN THE SAME MATERIAL

FINISHES:

SEAT: LUCIA MOONLIGHT/CANVAS TIMBER/CANVAS SISAL

FRAME: POLISHED CHROME, POWDER COAT BLACK MATTE OR BRONZE MATTE

APPROVAL: _____

SIGNATURE: _____

CROSSOVER
consultants



TAG: CH3-G

BACK ◀

ANDREU WORLD FLEX HIGH BACK WITH ARMS

MODEL NO: SO1301

W 20.75" x D 20.5" x H 32" x SH 18"

QTY 1



PRODUCT DETAILS

MANUFACTURER: ANDREU WORLD

PRODUCT: FLEX HIGH BACK WITH ARMS

DESCRIPTION: STACKABLE ARMCHAIR FULLY UPHOLSTERED WITH A SLED BASE, THERMO-POLYMER SEAT AND BACKREST

FINISHES:

SEAT: VALENCIA TAUPE (107-0034) WITH PARALLEL STITCHING

BASE: POLISHED CHROME

APPROVAL: _____

SIGNATURE: _____

CROSSOVER
consultants

TAG: CH3-H

BACK ◀

WALTER KNOLL SHERU WITH ARMS 4-STAR SWIVEL

MODEL NO: 1437
W 28.25" x D 24.25" x H 33" x SH 18.5"
QTY 1



PRODUCT DETAILS

MANUFACTURER: WALTER KNOLL

PRODUCT: SHERU CHAIR

DESCRIPTION: CHAIR WITH ARMRESTS, 4-STAR BASE, UPHOLSTERED FRONT AND BACK IN THE SAME MATERIAL

FINISHES:

SEAT: LUCIA MOONLIGHT/CANVAS TIMBER/CANVAS SISAL

FRAME: POLISHED CHROME, POWDER COAT BLACK MATTE OR BRONZE MATTE

APPROVAL: _____

SIGNATURE: _____



TAG: CH6-E

BACK ◀

SOURCE JUMP-CAFÉ CHAIR

MODEL NO: 280-SL-B6-NG-2807
W 22.5" x D 20.5" x H 32.25" x SH 17.75"
QTY 1



PRODUCT DETAILS

MANUFACTURER: SOURCE INTERNATIONAL
PRODUCT: JUMP-CAFÉ CHAIR
DESCRIPTION: POLY CHAIR WITH SLED FRAME AND CHROME BASE

FINISHES:
SEAT: CHARCOAL POLYPROPYLENE
EXTERIOR SHELL: BLACK POLYPROPYLENE
BASE: BLACK

APPROVAL: _____

SIGNATURE: _____

CROSSOVER
consultants



TAG: CH6-F

BACK ◀

ANDREU WORLD FLEX HIGH BACK

MODEL NO: SI1621

W 20.75" x D 20.5" x H 32" x SH 18"

QTY 1

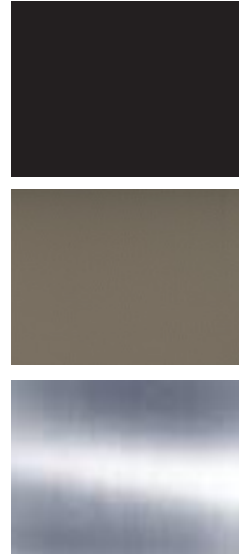

PRODUCT DETAILS

MANUFACTURER: ANDREU WORLD

PRODUCT: FLEX HIGH BACK

DESCRIPTION: STACKABLE CHAIR WITHOUT UPHOLSTERY, BLACK SHELL WITH POLISHED SLED BASE

FINISHES:

SEAT: BLACK/TAUPE POLYPROPYLENE

BASE: POLISHED ALUMINUM

APPROVAL: _____

SIGNATURE: _____

CROSSOVER
consultants



TAG: CH6-G

BACK ◀

WILKHAHN OCCO 4-LEG CHAIR

MODEL NO: 222/10

W 22 ½" x D 22 ¾" x H 32 ¼" x SH 17 3/8"

QTY 1



PRODUCT DETAILS

MANUFACTURER: WILKHAHN

PRODUCT: OCCO 4-LEG CHAIR

DESCRIPTION: OCCO 4-LEG CHAIR WITH POLYMER ARMRESTS AND POLY SHELL

FINISHES:

SEAT/BACK: BLACK POLY SHELL/GREY BEIGE POLY SHELL

FRAME: MATTE BLACK POWDER COAT /GREY BEIGE POWER COAT

APPROVAL: _____

SIGNATURE: _____

CROSSOVER
consultants



TAG: CH5-E

BACK ◀

DAVIS GINKGO CONSULT

MODEL NO: GKCN-100-WW
W 25.25" x D 23" x H 32" x SH 18.5"
QTY 1

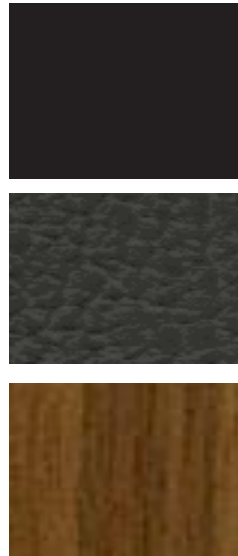

PRODUCT DETAILS

MANUFACTURER: DAVIS

PRODUCT: GINKGO CONSULT

DESCRIPTION: MID BACK CHAIR WITH ARMS, UPHOLSTERED BACK & SEAT PAD, LIGHT WALNUT SHELL, FOUR PRONG SWIVEL GLIDE BASE

FINISHES:

SEAT: DESIGNTEX SORANO KEYSTONE (GRADE C)

BACK: LIGHT WALNUT

BASE: BLACK

APPROVAL: _____

SIGNATURE: _____

CROSSOVER
consultants



TAG: CH5-C

BACK ◀

ANDREU WORLD FLEX CORPORATE

MODEL NO: SI1639

W 19.75" x D 19.75" x SH 18"

QTY 1



PRODUCT DETAILS

MANUFACTURER: ANDREU WORLD

PRODUCT: FLEX CORPORATE

DESCRIPTION: ARMLESS CHAIR WITH 4-STAR CENTRAL ALUMINUM SWIVEL BASE WITH SELF RETURN, FULLY UPHOLSTERED IN VALENCIA SCHWARZ WITH PARALLEL STITCHING

FINISHES:

SEAT: VALENCIA SCHWARZ OR TAUPE WITH PARALLEL STITCHING

BASE: BLACK

APPROVAL: _____

SIGNATURE: _____

CROSSOVER
consultants



TAG: CH5-F

BACK ◀

SOURCE JUMP HIGH FOUR SWIVEL

MODEL NO: 280-H4

W 26.25" x D 26.25" x H 31.5" x SH 18"

QTY 1



PRODUCT DETAILS

MANUFACTURER: SOURCE INTERNATIONAL

PRODUCT: JUMP HIGH FOUR SWIVEL CHAIR

DESCRIPTION: ARMLESS CHAIR WITH CROME LEGS

FINISHES:

SEAT: BLACK FAUX LEATHER

BASE: BLACK

APPROVAL: _____

SIGNATURE: _____



TAG: CH5-G

BACK ◀

WALTER KNOLL KYO CONSULT CHAIR

MODEL NO: 1343

W 27.5" x D 27.5" x H 32" x SH 19"

QTY 1

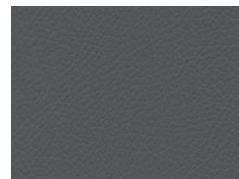

PRODUCT DETAILS

MANUFACTURER: WALTER KNOLL

PRODUCT: KYO CONSULT

DESCRIPTION: BUCKET CHAIR, FULLY UPHOLSTERED WITH 4-STAR SWIVEL BASE, WITH GLIDES

FINISHES:

SEAT: FABRIC SKAI COLORS BIRCH, ANTHRACITE OR BLACK

FRAME: POLISHED CHROME. POWDER COAT MATTE BLACK OR MATTE BRONZE

APPROVAL: _____

SIGNATURE: _____



TAG: CH7-G

BACK ◀

SOURCE JUMP BAR STOOL

MODEL NO: 282-STL30-B6
W 17.25" x D 18.75" x H 38" x SH 30.5"
QTY 1



PRODUCT DETAILS

MANUFACTURER: SOURCE INTERNATIONAL
PRODUCT: JUMP BAR STOOL
DESCRIPTION: LOW BACK STOOL WITH FOOTREST

FINISHES:
SEAT: MAHARAM LARIAT, COLOR BLACK 440401
BACK: MAHARAM LARIAT, COLOR BLACK 440401
BASE: BLACK

APPROVAL: _____

SIGNATURE: _____



TAG: CH7-F

BACK ◀

ANDREU WORLD FLEX BAR STOOL

MODEL NO: BQ1332

W 21" x D 19" x H 39" x SH 30"

QTY 1



PRODUCT DETAILS

MANUFACTURER: ANDREU WORLD

PRODUCT: FLEX BAR STOOL

DESCRIPTION: ARMLESS STACKABLE BAR STOOL WITH SLED BASE, FULLY UPHOLSTERED IN VALENCIA WITH PARALLEL STITCHING

FINISHES:

SEAT: VALENCIA TAUPE (107-0034), WITH PARALLEL STITCHING

BASE: POLISHED ALUMINUM

APPROVAL: _____

SIGNATURE: _____

CROSSOVER
consultants



TAG: CH7-B

BACK ◀

WALTER KNOLL TURTLE STOOL

MODEL NO: 1853

W 16" x D 17" x H 33" x SH 30"

QTY 1

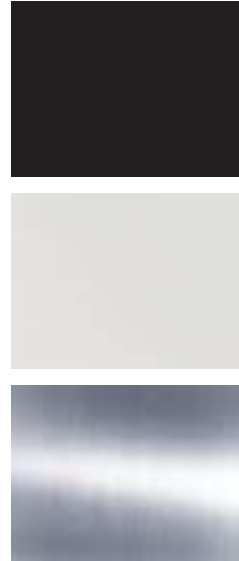

PRODUCT DETAILS

MANUFACTURER: WALTER KNOLL

PRODUCT: TURTLE STOOL

DESCRIPTION: LOW BACK STOOL WITH FOOTREST AND ALUMINUM BASE

FINISHES:

SEAT: SOLITAIRE BLACK

BACK SHELL: WHITE SHELL

BASE: MATTE POLISHED ALUMINUM

APPROVAL: _____

SIGNATURE: _____



TAG: CH7-H

BACK ◀

WALTER KNOLL SHERU BARSTOOL

MODEL NO: 1455
W 20" x D 20.25" x H 40.25" x SH 29.75"
QTY 1

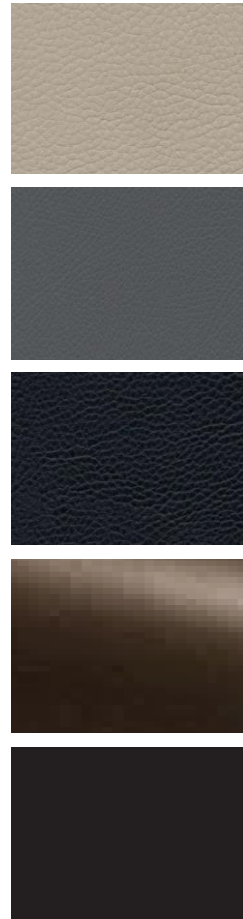

PRODUCT DETAILS

MANUFACTURER: WALTER KNOLL
PRODUCT: SHERU BARSTOOL
DESCRIPTION: HIGH BARSTOOL IN FAUX LEATHER

FINISHES:
SEAT: SKAI BIRKE/ANTHRACITE/SCHWARZ
FRAME: POLISHED CHROME, POWDER COAT MATTE BLACK, BRONZE MATTE

APPROVAL: _____

SIGNATURE: _____



TAG: L4-C

BACK ◀

DAVIS GINKGO LOW BACK

MODEL NO: GL-50-WW
W 27.5" x D 27.5" x H 29" x SH 16.25"
QTY 1



PRODUCT DETAILS

MANUFACTURER: DAVIS
PRODUCT: GINKGO LOW BACK
DESCRIPTION: LOW BACK CHAIR WITH INTERIOR UPHOLSTERY, EXPOSED VENEER SHELL, FOUR PRONG PEDESTAL BASE AND MEMORY RETURN SWIVEL

FINISHES:
SEAT: DAVIS FABRIC MOMENTUM FELT MELANGE, FELT MELANGE COLOR: CONSTANT OR GREIGE
BACK: LIGHT WALNUT SHELL
BASE: BLACK

APPROVAL: _____

SIGNATURE: _____



TAG: L4-F

BACK ◀

KNOLL D'URSO SWIVEL

MODEL NO: 100146533

W 32" x D 30" x H 27.75" x SH 19"

QTY 1



PRODUCT DETAILS

MANUFACTURER: KNOLL

PRODUCT: D'URSO SWIVEL

DESCRIPTION: SWIVEL CHAIR WITH RETURN TO CENTER MECHANISM

FINISHES:

SEAT: KNOLL HOPSACK BLACK K120616 OR HOPSACK PUTTY K120613

BASE: POLISHED ALUMINUM

APPROVAL: _____

SIGNATURE: _____

CROSSOVER
consultants



TAG: L4-G

BACK ◀

ALLERMUIR LOLA CHAIR

MODEL NO: A820

W 22" x D 26" x H 30" x SH 17"

QTY 1

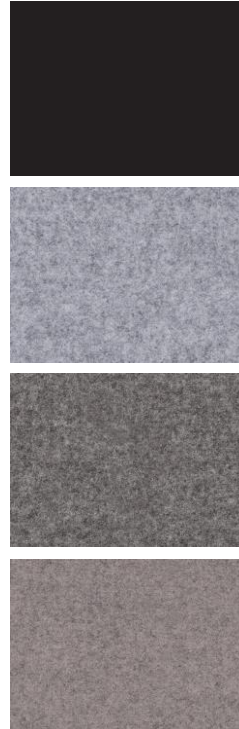

PRODUCT DETAILS

MANUFACTURER: ALLERMUIR

PRODUCT: LOLA CHAIR

DESCRIPTION: LOLA CHAIR WITH SWIVEL POLISHED CHROME PEDESTAL BASE, UPHOLSTERED

FINISHES:

SEAT: CAMIRA BLAZER SILVERDALE/SURREY/SAINT ANDREWS

FRAME: BLACK

APPROVAL: _____

SIGNATURE: _____



TAG: L4-D

BACK ◀

ANDREU WORLD FLEX EXECUTIVE CHAIR

MODEL NO: BU1892

W 24.5" x D 24.75" x H 32.75" x SH 16.5"

QTY 1



PRODUCT DETAILS

MANUFACTURER: ANDREU WORLD

PRODUCT: FLEX EXECUTIVE

DESCRIPTION: LOW BACK ARMLESS LOUNGE CHAIR WITH 4-STAR ALUMINUM SWIVEL BASE WITH SELF RETURN, UPHOLSTERED IN VALENCIA TAUPE WITH PARALLEL STITCHING

FINISHES:

SEAT: VALENCIA TAUPE, VALENCIA SCHAWRZ, WITH PARALLEL STITCHING

FRAME: BLACK

APPROVAL: _____

SIGNATURE: _____

CROSSOVER
consultants

TAG: L4-E

BACK ◀

ALLERMUIR OPEN CHAIR

MODEL NO: A640

W 30.75" x D 34" x H 41.5" x SH 18"

QTY 1



PRODUCT DETAILS

MANUFACTURER: ALLERMUIR

PRODUCT: OPEN CHAIR

DESCRIPTION: OPEN LOUNGE CHAIR WITH 4-STAR POLISHED ALUMINUM BASE, AVAILABLE WITH OR WITHOUT HEADREST

FINISHES:

SEAT: MAHARAM BLUF LUMOS

EXTERIOR: KNOLL RANSOM CAPER

FRAME: BLACK

APPROVAL: _____

SIGNATURE: _____

CROSSOVER
consultants



TAG: CH4-H

WALTER KNOLL KYO

MODEL NO: 171-10

W 30" x D 32" x H 36" x SH 18"

QTY 1

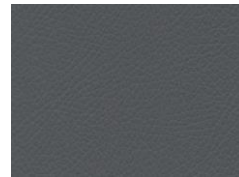

BACK ◀

PRODUCT DETAILS

MANUFACTURER: WALTER KNOLL

PRODUCT: KYO LOUNGE

DESCRIPTION: KYO LOUNGE ARMCHAIR, SEAT AND BACK UPHOLSTERED, POWDER COAT MATT BLACK OR BRONZE BASE

FINISHES:

SEAT: FABRIC SKAI COLORS BIRCH, ANTHRACITE OR BLACK, LUCIA MOONLIGHT

FRAME: POLISHED CHROME. POWDER COAT MATTE BLACK OR MATTE BRONZE

APPROVAL: _____

SIGNATURE: _____



TAG: AS-CH5-C

BACK ◀

DAVIS GINKGO CONSULT CHAIR-SPORT

MODEL NO: GKCN-100-OA
W 24.25" x D 23" x H 32" x SH 18.5"
QTY 1

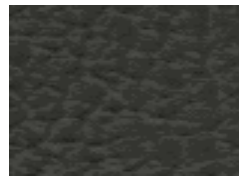

PRODUCT DETAILS

MANUFACTURER: DAVIS

PRODUCT: GINKGO CONSULT

DESCRIPTION: MID BACK CONSULT CHAIR WITH ARMS, OAK SHELL AND FOUR PRONG SWIVEL GLIDE BASE, UPHOLSTERED BACK & SEAT PAD

FINISHES:

SEAT: DESIGNTEX SORANO KEYSTONE (GRADE C)

BACK: BROWN OAK SHELL

BASE: MATTE BLACK ALUMINUM

APPROVAL: _____

SIGNATURE: _____

CROSSOVER
consultants



TAG: AS-CH5-B

BACK ◀

ANDREU WORLD FLEX CORPORATE CHAIR-SPORT

MODEL NO: SI1639

W 19.75" x D 19.75" x SH 18"

QTY 1



PRODUCT DETAILS

MANUFACTURER: ANDREU WORLD

PRODUCT: FLEX CORPORATE

DESCRIPTION: ARMLESS CONSULT CHAIR WITH 4-STAR BLACK POWDER COATED SWIVEL BASE WITH SELF RETURN, UPHOLSTERED IN VALENCIA SCHWARZ WITH PARALLEL STITCHING

FINISHES:

SEAT: VALENCIA SCHWARZ, WITH PARALLEL STITCHING

BASE: BLACK POWDER COATED

APPROVAL: _____

SIGNATURE: _____

CROSSOVER
consultants



TAG: AS-CH5-D

BACK ◀

WALTER KNOLL KYO CONSULT CHAIR-SPORT

MODEL NO: 1343

W 27.5" x D 27.5" x H 32" x SH 19"

QTY 1

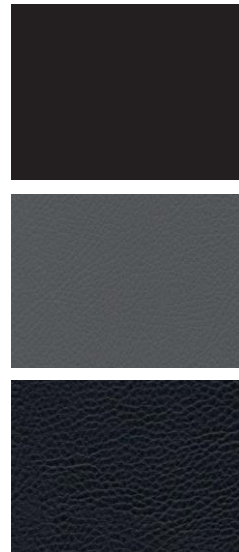

PRODUCT DETAILS

MANUFACTURER: WALTER KNOLL

PRODUCT: KYO CONSULT CHAIR

DESCRIPTION: BUCKET CHAIR, FULLY UPHOLSTERED WITH 4-STAR SWIVEL BASE, WITH GLIDES

FINISHES:

SEAT: SKAI ANTHRACITE OR BLACK

FRAME: POWDER COAT BLACK MATTE

APPROVAL: _____

SIGNATURE: _____

CROSSOVER
consultants



TAG: AS-L4-C

BACK ◀

DAVIS GINKGO LOW BACK CHAIR-SPORT

MODEL NO: GL-50-OA

W 27.5" x D 27.5" x H 29" x SH 16.25"

QTY 1



PRODUCT DETAILS

MANUFACTURER: DAVIS

PRODUCT: GINKGO LOW BACK

DESCRIPTION: LOW BACK, INTERIOR UPHOLSTERY EXPOSED VENEER SHELL, FOUR PRONG PEDESTAL BASE, MEMORY RETURN SWIVEL

FINISHES:

SEAT: DESIGNTEX SORANO KEYSTONE (GRADE C)

BACK SHELL: BROWN OAK FINISH

BASE: BLACK ALUMINUM

APPROVAL: _____

SIGNATURE: _____

CROSSOVER
consultants



TAG: AS-L4-D

BACK ◀

ANDREU WORLD FLEX EXECUTIVE CHAIR-SPORT

MODEL NO: BU1892

W 24.5" x D 24.75" x H 32.75" x SH 16.5"

QTY 1



PRODUCT DETAILS

MANUFACTURER: ANDREU WORLD

PRODUCT: FLEX EXECUTIVE

DESCRIPTION: LOW BACK ARMLESS LOUNGE CHAIR WITH 4-STAR SWIVEL BLACK POWDER COATED BASE WITH SELF RETURN, UPHOLSTERED IN VALENCIA SCHWARZ WITH PARALLEL STITCHING

FINISHES:

SEAT: VALENCIA SCWARZ, WITH PARALLEL STITCHING

BASE: BLACK POWDER COATED

APPROVAL: _____

SIGNATURE: _____

CROSSOVER
consultants



TAG: AS-L4-E

BACK ◀

WALTER KNOLL KYO-SPORT

MODEL NO: 171-10

W 30 " x D 32" x H 36" x SH 18"

QTY 1

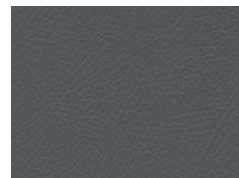

PRODUCT DETAILS

MANUFACTURER: WALTER KNOLL

PRODUCT: KYO LOUNGE

DESCRIPTION: KYO LOUNGE ARMCHAIR, SEAT AND BACK UPHOLSTERED, POWDER COAT MATT BLACK BASE

FINISHES:

SEAT: FABRIC SKAI COLORS ANTHRACITE OR BLACK, LUCIA MOONLIGHT

FRAME: POLISHED CHROME. POWDER COAT MATTE BLACK

APPROVAL: _____

SIGNATURE: _____

CROSSOVER
consultants



TAG: L1-D

BACK ◀

ANDREU WORLD RAGLAN CLUB CHAIR

MODEL NO: BU2065

W 33.5" x D 29.5" x H 28.25" x SH 17.5"

QTY 1

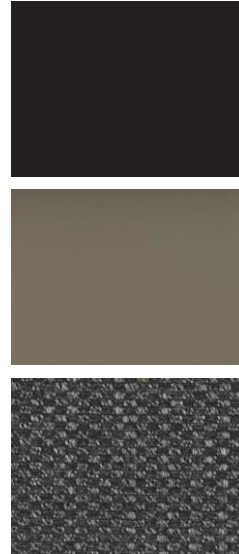

PRODUCT DETAILS

MANUFACTURER: ANDREU WORLD

PRODUCT: RAGLAN LOUNGE CHAIR

DESCRIPTION: CLUB CHAIR, UPHOLSTERED SEAT IN VALENCIA TAUPE AND LEGS IN POLISHED ALUMINUM OR BLACK POWDER COATING

FINISHES:

SEAT: VALENCIA TAUPE/SCHWARZ OR DESIGNTEX BARK CLOTH, DARK CHARCOAL

FRAME/LEGS: ALUMINUM OR MATTE BLACK POWDER COAT

APPROVAL: _____

SIGNATURE: _____

CROSSOVER
consultants

TAG: L1-D-L

BACK ◀

ANDREU WORLD RAGLAN LEFT ARM CHAIR

MODEL NO: SF2068

W 33.5" x D 29.5" x H 28.25" x SH 17.5"

QTY 1

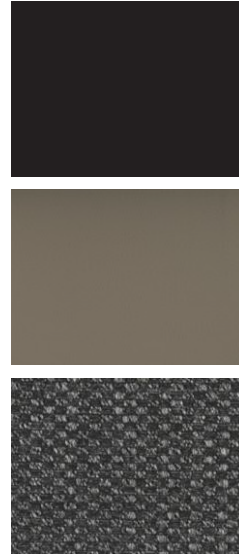

PRODUCT DETAILS

MANUFACTURER: ANDREU WORLD

PRODUCT: RAGLAN LEFT ARM

DESCRIPTION: 1-SEATER CORNER SOFA, UPHOLSTERED SEAT IN VALENCIA TAUPE WITH LEGS IN POLISHED ALUMINUM OR BLACK POWDER COATING

FINISHES:

SEAT: VALENCIA TAUPE/SCHWARZ OR DESIGNTEX BARK CLOTH, DARK CHARCOAL

BASE/LEGS: MATTE BLACK POWDER COAT

APPROVAL: _____

SIGNATURE: _____

CROSSOVER
consultants



TAG: L1-D-R

BACK ◀

ANDREU WORLD RAGLAN RIGHT ARM CHAIR

MODEL NO: SF2069

W 33.5" x D 29.5" x H 28.25" x SH 17.5"

QTY 1

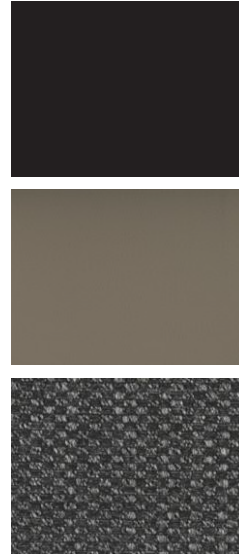

PRODUCT DETAILS

MANUFACTURER: ANDREU WORLD

PRODUCT: RAGLAN RIGHT ARM

DESCRIPTION: 1-SEATER CORNER SOFA, UPHOLSTERED SEAT IN VALENCIA TAUPE WITH LEGS IN POLISHED ALUMINUM OR BLACK POWDER COATING

FINISHES:

SEAT: VALENCIA TAUPE/SCHWARZ OR DESIGNTEX BARK CLOTH, DARK CHARCOAL

BASE/LEGS: MATTE BLACK POWDER COAT

APPROVAL: _____

SIGNATURE: _____

CROSSOVER
consultants



TAG: L1-F

BACK ◀

STYLEX NYC WRAPOVER CHAIR

MODEL NO: 111B24

W 34.5" x D 34.5" x H 29.5" x SH 17.5"

QTY 1

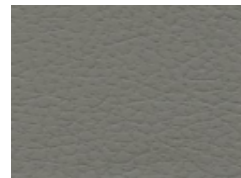

PRODUCT DETAILS

MANUFACTURER: STYLEX

PRODUCT: NYC WRAPOVER CHAIR

DESCRIPTION: CLUB CHAIR IN BRISA WITH BLACK MATTE LEGS

FINISHES:

SEAT: BRISA HEAVY DUTY, TAUPE OR BLACK

LEGS: BLACK MATTE

APPROVAL: _____

SIGNATURE: _____



TAG: L1-G

BACK ◀

MUUTO OUTLINE CHAIR

MODEL NO: MOUTC-BLACK-M156163

W 30.75 " x D 30 " x H 27.5 "

QTY 1

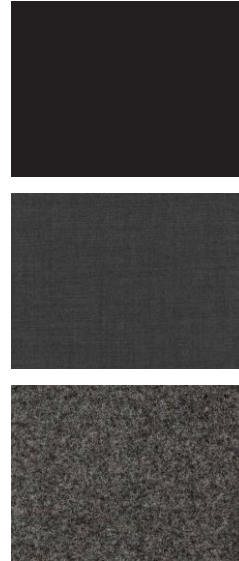

PRODUCT DETAILS

MANUFACTURER: MUUTO

PRODUCT: OUTLINE CHAIR

DESCRIPTION: MUUTO OUTLINE ARMCHAIR ON BLACK BASE

FINISHES:

SEAT: KVADRAT REMIX 3 COLOR 163, OR DIVINA MELANGE COLOR 170

BACK: BLACK MESH

BASE: BLACK POWDER COATED ALUMINUM

APPROVAL: _____

SIGNATURE: _____

CROSSOVER
consultants



TAG: L15-D

BACK ◀

BERNHARDT B.2 LOUNGE CHAIR

MODEL NO: 6902S

W 29" x D 29" x H 27" x SH 16"

QTY 1



PRODUCT DETAILS

MANUFACTURER: BERNHARDT

PRODUCT: B.2 LOUNGE CHAIR

DESCRIPTION: ARMLESS LOUNGE CHAIR WITH UPHOLSTERED SEAT AND POLISHED BASE

FINISHES:

SEAT: ALLUDE

FRAME: POLISHED ALUMINUM

APPROVAL: _____

SIGNATURE: _____

CROSSOVER
consultants

TAG: L10-C

BACK ◀

ANDREU WORLD RAGLAN SOFA

MODEL NO: SF2066

W 63" x D 29.5" x SH 17"

QTY 1

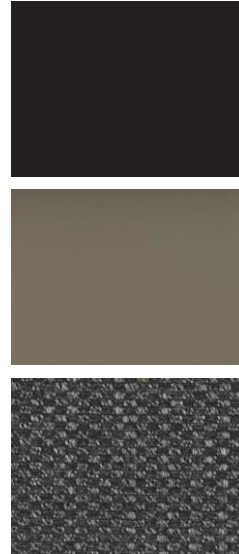

PRODUCT DETAILS

MANUFACTURER: ANDREU WORLD

PRODUCT: RAGLAN 2-SEATER SOFA

DESCRIPTION: 2-SEATER SOFA WITH ARMRESTS, FABRIC SEAT & BACK, ALUMINUM OR MATTE LEG OPTION

FINISHES:

SEAT: VALENCIA/VALENCIA TAUPE/BARK CLOTH

FRAME: ALUMINUM OR MATTE BLACK POWDER COAT

APPROVAL: _____

SIGNATURE: _____

CROSSOVER
consultants

TAG: L10-C-L

BACK ◀

ANDREU WORLD RAGLAN LEFT ARM SOFA

MODEL NO: SF2070

W 47.5" x D 29.5" x SH 17"

QTY 1

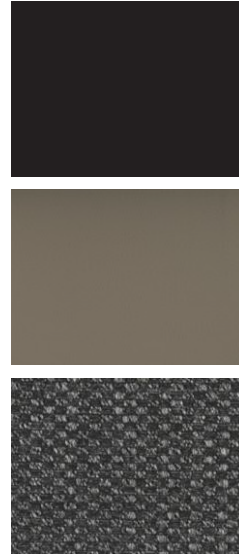

PRODUCT DETAILS

MANUFACTURER: ANDREU WORLD

PRODUCT: RAGLAN LEFT ARM 2-SEATER SOFA

DESCRIPTION: 2-SEATER SOFA WITH LEFT ARM ONLY, FABRIC SEAT & BACK, ALUMINUM OR MATTE LEG OPTION

FINISHES:

SEAT: VALENCIA/VALENCIA TAUPE/BARK CLOTH

FRAME: ALUMINUM OR MATTE BLACK POWDER COAT

APPROVAL: _____

SIGNATURE: _____

CROSSOVER
consultants



TAG: L10-C-R

BACK ◀

ANDREU WORLD RAGLAN RIGHT ARM SOFA

MODEL NO: SF2071

W 47.5" x D 29.5" x SH 17"

QTY 1

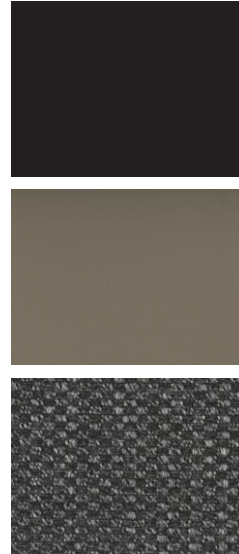

PRODUCT DETAILS

MANUFACTURER: ANDREU WORLD

PRODUCT: RAGLAN RIGHT ARM 2-SEATER SOFA

DESCRIPTION: 2-SEATER SOFA WITH RIGHT ARM ONLY, FABRIC SEAT & BACK, ALUMINUM OR MATTE LEG OPTION

FINISHES:

SEAT: VALENCIA/VALENCIA TAUPE/BARK CLOTH

FRAME: ALUMINUM OR MATTE BLACK POWDER COAT

APPROVAL: _____

SIGNATURE: _____

CROSSOVER
consultants



TAG: L10-E

BACK ◀

STYLEX NYC WRAPOVER SOFA

MODEL NO: 121B24

W 68" x D 34.5" x H 29.5" x SH 17.5"

QTY 1



PRODUCT DETAILS

MANUFACTURER: STYLEX

PRODUCT: NYC WRAPOVER 2-SEAT SOFA

DESCRIPTION: 2-SEAT SOFA WITH ARMS & BLACK MATTE LEGS

FINISHES:

SEAT: ULTRAFABRICS ULTRALEATHER PRO, COLOR DARK KNIGHT 554-5618

FRAME & LEGS: BLACK MATTE

APPROVAL: _____

SIGNATURE: _____

CROSSOVER
consultants



TAG: L13-A

BACK ◀

MARTIN BRATTRUD MEDINAH LOW BACK BENCH

MODEL NO: 1924

W 60" x D 28" x H 33" x SH 17.5"

QTY 1

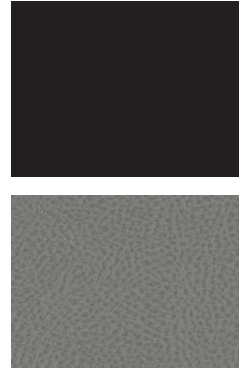

PRODUCT DETAILS

MANUFACTURER: MARTIN BRATTRUD

PRODUCT: MEDINAH LOW BACK

DESCRIPTION: ARMLESS, LOW BACK BANQUETTE WITH BLACK LEGS

FINISHES:

SEAT: MAHARAM LARIAT ZINC

LEGS: BLACK

APPROVAL: _____

SIGNATURE: _____



TAG: L13-B

BACK ◀

WALTER KNOLL FOSTER BENCH

MODEL NO: FOSTER 512
W 94" x D 28" x H 27" X SH 18"
QTY 1

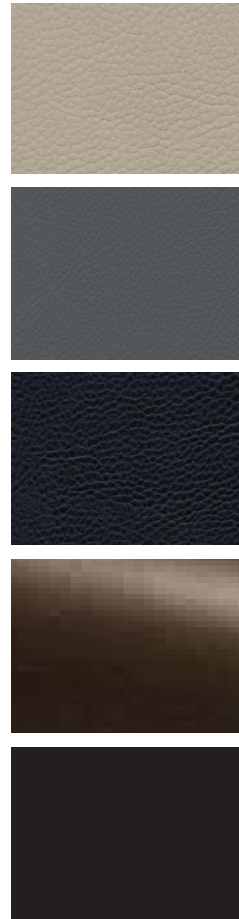

PRODUCT DETAILS

MANUFACTURER: WALTER KNOLL

PRODUCT: FOSTER BENCH

DESCRIPTION: ARMLESS BENCH, OPTION FOR HIGH BACK SCREEN AND POWER
18" SEAT HEIGHT

UPHOLSTERY:

SEAT: SKAI BIRKE/ANTHRACITE/SCHWARZ

FRAME: POLISHED CHROME, POWDER COAT MATTE BLACK, BRONZE MATTE

APPROVAL: _____

SIGNATURE: _____



TAG: L13-C

BACK ◀

WILKHAHN INSIT BENCH

MODEL NO: 783/55

W 65" or 94.5" x D 25.25" x H 33" x SH 17.75"

QTY 1



PRODUCT DETAILS

MANUFACTURER: WILKHAHN

PRODUCT: INSIT

DESCRIPTION: BENCH WITH BACKREST, OPTION FOR HIGH BACK SCREEN. TWO OR THREE SEAT OPTION

FINISHES:

SEAT: FAUX LEATHER EVIDA

LEGS: BLACK

APPROVAL: _____

SIGNATURE: _____

CROSSOVER
consultants



TAG: L12-C

BACK ◀

DAVIS TWO-SEATER HIGH BACK - ARMS

MODEL NO: SBSH-2000

W 63" x D 32" x H 47 ¼" x SH 16 1/8"

QTY 1

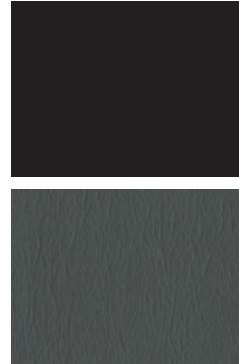

PRODUCT DETAILS

MANUFACTURER: DAVIS

PRODUCT: TWO-SEATER HIGH BACK

DESCRIPTION: DAVIS UPHOLSTERED TWO-SEATER HIGH BACK SOFA

FINISHES:

SEAT/BACK: ULTRAFABRICS/ ULTRALEATHER/ SCHOONER (DAVIS GRADE D)

EXTERIOR BACK: LINQ UPHOLSTERY/ CHARCOAL

BASE: POLISHED ALUMINUM

APPROVAL: _____

SIGNATURE: _____



TAG: L12-C

BACK ◀

DAVIS TWO-SEATER HIGH BACK – RIGHT ARM

MODEL NO: SBSH-2002-L
W 63" x D 32" x H 47 ¼" x SH 16 1/8"
QTY 1

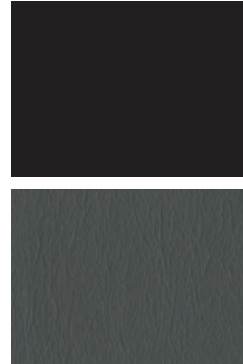

PRODUCT DETAILS

MANUFACTURER: DAVIS
PRODUCT: TWO-SEATER HIGH BACK
DESCRIPTION: DAVIS UPHOLSTERED TWO-SEATER HIGH BACK SOFA

FINISHES:
SEAT/BACK: ULTRAFABRICS/ ULTRALEATHER/ SCHOONER (DAVIS GRADE D)
EXTERIOR BACK: LINQ UPHOLSTERY/ CHARCOAL
BASE: POLISHED ALUMINUM

APPROVAL: _____

SIGNATURE: _____

TAG: L12-C

BACK ◀

DAVIS TWO-SEATER HIGH BACK – LEFT ARM

MODEL NO: SBSH-2002-R

W 63" x D 32" x H 47 ¼" x SH 16 1/8"

QTY 1

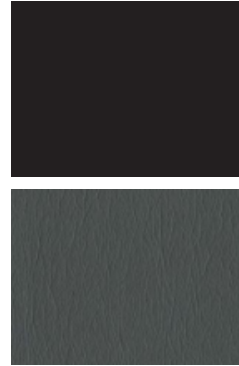

PRODUCT DETAILS

MANUFACTURER: DAVIS

PRODUCT: TWO-SEATER HIGH BACK

DESCRIPTION: DAVIS UPHOLSTERED TWO-SEATER HIGH BACK SOFA

FINISHES:

SEAT/BACK: ULTRAFABRICS/ ULTRALEATHER/ SCHOONER (DAVIS GRADE D)

EXTERIOR BACK: LINQ UPHOLSTERY/ CHARCOAL

BASE: POLISHED ALUMINUM

APPROVAL: _____

SIGNATURE: _____



TAG: L18-C

BACK ◀

ANDREU WORLD RAGLAN-3 SEAT SOFA

MODEL NO: SF2067

76.75"W X 29.5"D X 28.25"H X 17"SH

QTY 1

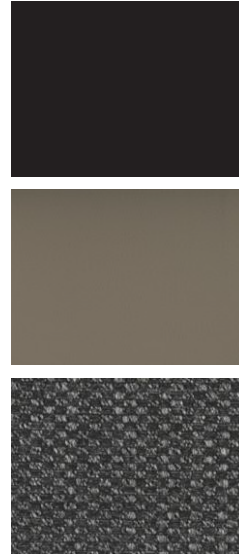

PRODUCT DETAILS

MANUFACTURER: ANDREU WORLD

PRODUCT: RAGLAN SOFA

DESCRIPTION: ANDREU WORLD UPHOLSTERED THREE SEAT SOFA

FINISHES:

SEAT/BACK: VALENCIA TAUPE, VALENCIA SCHWARZ OR DESIGNTEX BARK/DARK CHARCOAL

BASE: POLISHED ALUMINUM OR BLACK POWDERCOAT

APPROVAL: _____

SIGNATURE: _____

CROSSOVER
consultants



TAG: L18-E

BACK ◀

STYLEX NYC WRAPOVER 3-SEAT SOFA

MODEL NO: NY131B24

98"W X 34.5"D X 29.5"H X 17.5"SH

QTY 1

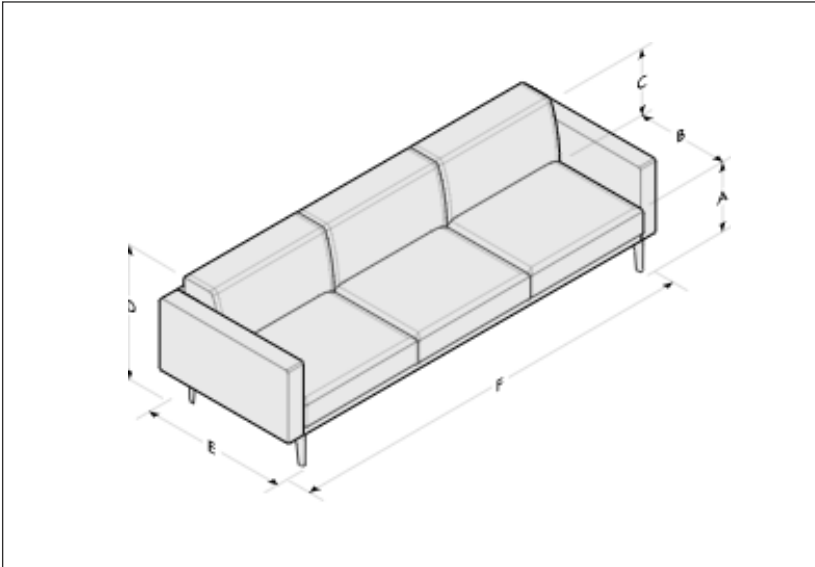

PRODUCT DETAILS

MANUFACTURER: STYLEX

PRODUCT: NYC WRAPOVER SOFA

DESCRIPTION: STYLEX NYC WRAPOVER THREE SEAT SOFA

FINISHES:

SEAT/BACK: ULTRAFABRICS BRISA ASH, BRISA BLACK ONYX

BASE: BLACK POWDERCOAT

APPROVAL: _____

SIGNATURE: _____



TAG: L14-A

BACK ◀

WALTER KNOLL JAAN

MODEL NO: TBD

SIZE TBD

QTY 1



PRODUCT DETAILS

MANUFACTURER: WALTER KNOLL

PRODUCT: JAAN SECTIONAL

DESCRIPTION: WALTER KNOLL JAAN SECTIONAL MODULAR SOFA

FINISHES:

SEAT/BACK: SKAI COLOR BIRCH, ANTHRACITE OR BLACK

BASE: BLACK POWDERCOAT OR BRONZE POWDERCOAT

APPROVAL: _____

SIGNATURE: _____



TAG: L14-B

BACK ◀

STYLEX NYC WRAPOVER SECTIONAL

MODEL NO: TBD

SIZE TBD

QTY 1

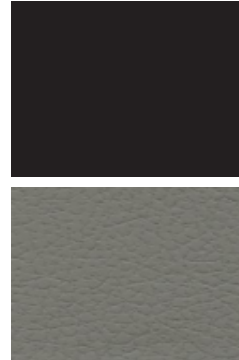
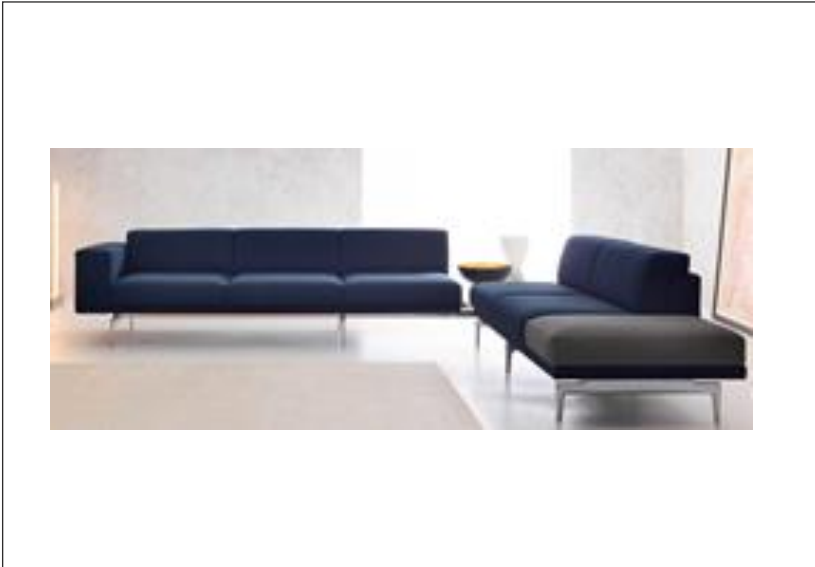

PRODUCT DETAILS

MANUFACTURER: STYLEX

PRODUCT: NYC WRAPOVER SECTIONAL

DESCRIPTION: STYLEX NYC WRAPOVER SECTIONAL MODULAR SOFA

FINISHES:

SEAT/BACK: ULTRAFABRICS BRISA ASH, BRISA BLACK ONYX

BASE: BLACK POWDERCOAT

APPROVAL: _____

SIGNATURE: _____



TAG: L16-B

BACK ◀

MUUTO FIVE POUF-LARGE

MODEL NO: 10009123
W 34.5" x D 34.5" x H 17.75"
QTY 1



PRODUCT DETAILS

MANUFACTURER: MUUTO
PRODUCT: FIVE POUF
DESCRIPTION: MUUTO FIVE POUF-LARGE

FINISHES:
SEAT/BACK: KVADRAT REMIX COLOR 183

APPROVAL: _____
SIGNATURE: _____



TAG: L16-C

BACK ◀

MUUTO FIVE POUF- EXTRA LARGE

MODEL NO: 100142666

W 55" x D 55" x H 17.75"

QTY 1



PRODUCT DETAILS

MANUFACTURER: MUUTO

PRODUCT: FIVE POUF

DESCRIPTION: MUUTO FIVE POUF-EXTRA LARGE

FINISHES:

SEAT/BACK: KVADRAT REMIX COLOR 183

APPROVAL: _____

SIGNATURE: _____

CROSSOVER
consultants

TABLES





TAG: T2-F

BACK ◀

KFI STUDIOS PROOF ROUND DINING

MODEL NO: FK30RD-B2015-SL-D354

DIAM 30" x H 29"

QTY 1



PRODUCT DETAILS

MANUFACTURER: KFI STUDIOS

PRODUCT: PROOF DINING TABLE WITH KNIFE EDGE

DESCRIPTION: KFI STUDIOS PROOF DINING WITH KNIFE EDGE ON X BASE

FINISHES:

TOP: WHITE LAMINATE/BLACK LAMINATE

BASE: BLACK

APPROVAL: _____

SIGNATURE: _____



TAG: T2-E

BACK ◀

ALLERMUIR OPEN DINING TABLE

MODEL NO: A646-30RD

DIAM 30" x H29"

QTY 1



PRODUCT DETAILS

MANUFACTURER: ALLERMUIR

PRODUCT: OPEN ROUND DINING HEIGHT TABLE

DESCRIPTION: ALLERMUIR OPEN DINING TABLE WITH KNIFE EDGE ON X BASE

FINISHES:

TOP: WHITE LAMINATE

BASE: BLACK

APPROVAL: _____

SIGNATURE: _____

CROSSOVER
consultants



TAG: T2-G

BACK ◀

WALTER KNOLL LOX TABLE

MODEL NO: 109-T2
W 31" x D 31" x H 28"
QTY 1



PRODUCT DETAILS

MANUFACTURER: WALTER KNOLL
PRODUCT: LOX TABLE
DESCRIPTION: WALTER KNOLL LOX TABLE WITH ROUNDED CORNERS

FINISHES:
TOP: FENIX BLACK
BASE: POWDER COATED BLACK

APPROVAL: _____

SIGNATURE: _____



TAG: T2-H

BACK ◀

WILKHAHN INSIT TABLE

MODEL NO: 780/1
DIAM 27.5" x H 29"
QTY 1



PRODUCT DETAILS

MANUFACTURER: WILKHAHN

PRODUCT: INSIT TABLE

DESCRIPTION: WILKHAHN INSIT ROUND TABLE WITH KNIFE EDGE ON ROUND BASE

FINISHES:

TOP: WHITE OR BLACK LAMINATE

BASE: POWDER COATED BLACK

APPROVAL: _____

SIGNATURE: _____

CROSSOVER
consultants



TAG: T3-F

BACK ◀

KFI STUDIOS PROOF ROUND BAR TABLE

MODEL NO: FK30RD-B2015-SL-41-D354

DIAM 30" x H 41"

QTY 1



PRODUCT DETAILS

MANUFACTURER: KFI STUDIOS

PRODUCT: PROOF BAR HEIGHT TABLE WITH KNIFE EDGE

DESCRIPTION: KFI STUDIOS PROOF BAR HEIGHT WITH KNIFE EDGE ON X BASE

FINISHES:

TOP: WHITE LAMINATE

BASE: SILVER

APPROVAL: _____

SIGNATURE: _____

CROSSOVER
consultants



TAG: T3-E

BACK ◀

ALLERMUIR OPEN BAR TABLE

MODEL NO: A48-30RD

DIAM 30" x H 40"

QTY 1

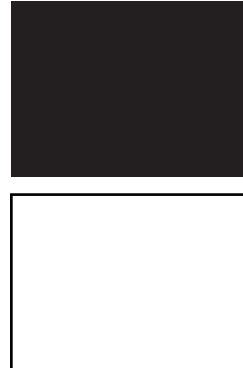

PRODUCT DETAILS

MANUFACTURER: ALLERMUIR

PRODUCT: OPEN ROUND BAR HEIGHT TABLE

DESCRIPTION: ALLERMUIR OPEN DINING TABLE WITH KNIFE EDGE ON X BASE

FINISHES:

TOP: WHITE LAMINATE

BASE: POLISHED ALUMINUM

APPROVAL: _____

SIGNATURE: _____



TAG: T1-G

BACK ◀

ALLERMUIR OPEN LOW TABLE

MODEL NO: IQB000229

DIAM 30" x H 18"

QTY 1



PRODUCT DETAILS

MANUFACTURER: ALLERMUIR

PRODUCT: OPEN ROUND LOW TABLE

DESCRIPTION: ALLERMUIR OPEN LOW TABLE WITH KNIFE EDGE ON X BASE

FINISHES:

TOP: SMOKY BROWN PEAR LAMINATE

BASE: BLACK

APPROVAL: _____

SIGNATURE: _____

CROSSOVER
consultants



TAG: AS-T1-D

BACK ◀

ALLERUIR OPEN LOW TABLE-SPORT

MODEL NO: IQB000229

DIAM 30" x H 18"

QTY 1



PRODUCT DETAILS

MANUFACTURER: ALLERUIR

PRODUCT: OPEN ROUND LOW TABLE

DESCRIPTION: ALLERUIR OPEN LOW TABLE WITH KNIFE EDGE ON X BASE

FINISHES:

TOP: BLACK LAMINATE

BASE: POWDER COATED BLACK

APPROVAL: _____

SIGNATURE: _____

CROSSOVER
consultants

TAG: T1-JR

BACK ◀

DAVIS NORA RECTANGLE TABLE

MODEL NO: NR-3048-GL

W 48" x D 22" x H 14.5"

QTY 1



PRODUCT DETAILS

MANUFACTURER: DAVIS

PRODUCT: NORA RECTANGLE

DESCRIPTION: DAVIS RECTANGLE COFFEE TABLE, BLACK PAINTED GLASS ON MATTE BLACK LEGS

FINISHES:

TOP: BLACK PAINTED GLASS

BASE: MATTE BLACK

APPROVAL: _____

SIGNATURE: _____



TAG: T1-JS

BACK ◀

DAVIS NORA SQUARE TABLE

MODEL NO: NR-3036-GL

W 36" x D 36" x H 14.5"

QTY 1

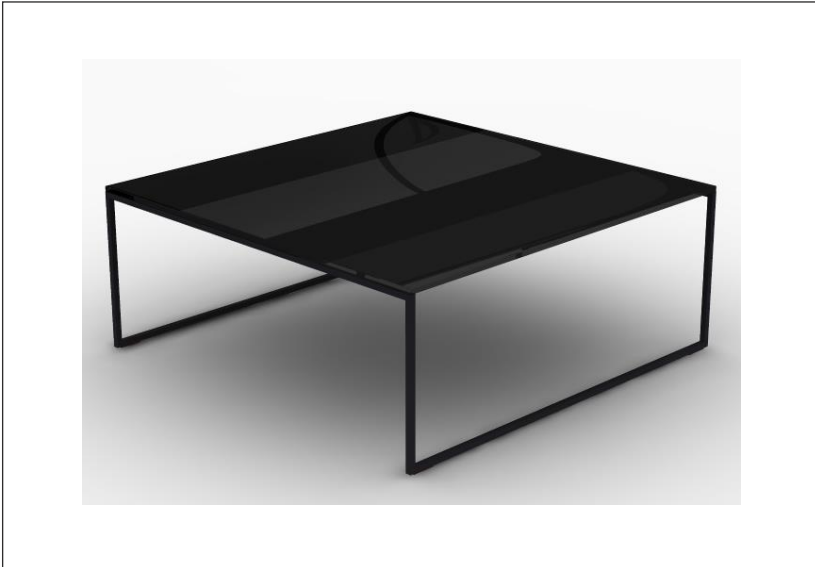

PRODUCT DETAILS

MANUFACTURER: DAVIS

PRODUCT: NORA SQUARE

DESCRIPTION: DAVIS SQUARE COFFEE TABLE, BLACK PAINTED GLASS ON MATTE BLACK LEGS

FINISHES:

TOP: BLACK PAINTED GLASS

BASE: MATTE BLACK

APPROVAL: _____

SIGNATURE: _____

CROSSOVER
consultants



TAG: T1-LR

BACK ◀

FLORENCE KNOLL RECTANGLE

MODEL NO: 2511T-CO-G2

W 45" x D 22" x H 17"

QTY 1



PRODUCT DETAILS

MANUFACTURER: KNOLL

PRODUCT: FLORENCE KNOLL RECTANGLE

DESCRIPTION: FLORENCE KNOLL RECTANGLE COFFEE TABLE

FINISHES:

TOP: CLEAR GLASS

BASE: SATIN CHROME

APPROVAL: _____

SIGNATURE: _____



TAG: T1-LS

BACK ◀

FLORENCE KNOLL SQUARE

MODEL NO: 2510T-CO-G2

W 23.5" x D 23.5" x H 17"

QTY 1



PRODUCT DETAILS

MANUFACTURER: KNOLL

PRODUCT: FLORENCE KNOLL SQUARE

DESCRIPTION: FLORENCE KNOLL SQUARE COFFEE TABLE

FINISHES:

TOP: CLEAR GLASS, BLACK PAINTED GLASS

BASE: SATIN CHROME

APPROVAL: _____

SIGNATURE: _____

TAG: T1-N

BACK ◀

TRNK MARBLE PLINTH

MODEL NO: 7000530

W 34.4" x D 23.6" x H 10.6"

QTY 1



PRODUCT DETAILS

MANUFACTURER: TRNK

PRODUCT: MARBLE PLINTH

DESCRIPTION: TRNK MARBLE PLINTH, LOW BLACK MARBLE

FINISHES:

TOP/BASE: BLACK MARQUINA

APPROVAL: _____

SIGNATURE: _____



TAG: T1-O

BACK ◀

ANDREU WORLD RAGLAN TABLE-RECTANGLE

MODEL NO: ME8638

W 47.25" x D 23.75" x H 14.25"

QTY 1

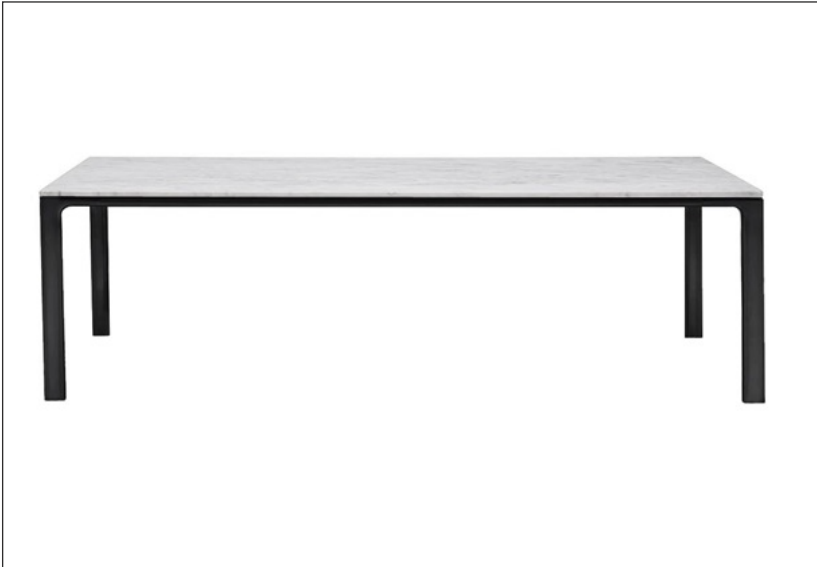

PRODUCT DETAILS

MANUFACTURER: ANDREU WORLD

PRODUCT: RAGLAN RECTANGLE COFFEE TABLE

DESCRIPTION: ANDREU WORLD RAGLAN RECTANGLE COFFEE TABLE WITH MARBLE TOP

FINISHES:

TOP: WHITE CARRARA

BASE: BLACK POWDER COATING

APPROVAL: _____

SIGNATURE: _____

CROSSOVER
consultants



TAG: T1-P

BACK ◀

ANDREU WORLD RAGLAN TABLE-SQUARE

MODEL NO: ME8632

W 23.75" x D 23.75" x H 14.25"

QTY 1



PRODUCT DETAILS

MANUFACTURER: ANDREU WORLD

PRODUCT: RAGLAN SQUARE COFFEE TABLE

DESCRIPTION: ANDREU WORLD RAGLAN SQUARE COFFEE TABLE WITH MARBLE TOP

FINISHES:

TOP: WHITE CARRARA

BASE: BLACK POWDER COATING

APPROVAL: _____

SIGNATURE: _____

CROSSOVER
consultants



TAG: T6-A

BACK ◀

HIGHTOWER RUBY SIDE TABLE

MODEL NO: HT6580B

DIAM 18" x H 18"

QTY 1



PRODUCT DETAILS

MANUFACTURER: HIGHTOWER

PRODUCT: RUBY ROUND SIDE TABLE

DESCRIPTION: OCCASIONAL TABLE MADE OF STEEL

FINISHES:

TOP & BASE: POWDER COAT BLACK

APPROVAL: _____

SIGNATURE: _____



TAG: T6-BR

BACK ◀

KNOLL SAARINEN ROUND

MODEL NO: 100162204

DIAM 20" x H 20"

QTY 1



PRODUCT DETAILS

MANUFACTURER: KNOLL

PRODUCT: SAARINEN ROUND SIDE TABLE

DESCRIPTION: SIDE TABLE WITH ALUMINUM PAINTED BASE AND MARBLE BEVELED EDGE TOP

FINISHES:

TOP: NERO MARQUINA SATIN

BASE: BLACK

APPROVAL: _____

SIGNATURE: _____

CROSSOVER
consultants



TAG: T6-BO

BACK ◀

KNOLL SAARINEN OVAL

MODEL NO: 100116345

W 22.5" x D 15" x H 20"

QTY 1



PRODUCT DETAILS

MANUFACTURER: KNOLL

PRODUCT: KNOLL SAARINEN OVAL SIDE TABLE

DESCRIPTION: SIDE TABLE WITH ALUMINUM PAINTED BASE AND MARBLE BEVELED EDGE TOP

FINISHES:

TOP: NERO MARQUINA SATIN

BASE: BLACK

APPROVAL: _____

SIGNATURE: _____

CROSSOVER
consultants



TAG: T6-D

BACK ◀

TRNK CLUSTER TABLES

MODEL NO: 3213

QTY 1



PRODUCT DETAILS

MANUFACTURER: TRNK

PRODUCT: CLUSTER TABLES

DESCRIPTION: TRNK CLUSTER TABLES (SET OF 3)

SMALL: W 3.5" x D 16" x H 13.75"

MEDIUM: W 14.5" x D 19.25" x H 15.75"

LARGE: W 15.75" x D 21.5" x H 17.75"

FINISHES:

BLACK METAL

APPROVAL: _____

SIGNATURE: _____



TAG: T7-A1

BACK ◀

WALTER KNOLL LOX TABLE

MODEL NO: 109-T5

W 25.5" x D 25.5" x H 25.5"

QTY 1



PRODUCT DETAILS

MANUFACTURER: WALTER KNOLL

PRODUCT: LOX TABLE

DESCRIPTION: OCCASSIONAL TABLE WITH ROUNDED CORNERS

FINISHES:

TOP: FENIX BLACK 109

BASE: POWDER-COATED MATT BLACK

APPROVAL: _____

SIGNATURE: _____

CROSSOVER
consultants



TAG: T7-A2

BACK ◀

WALTER KNOLL LOX TABLE

MODEL NO: 109-T5 SA

W 26" x D 26" x H 17"

QTY 1



PRODUCT DETAILS

MANUFACTURER: WALTER KNOLL

PRODUCT: LOX TABLE

DESCRIPTION: OCCASSIONAL TABLE WITH ROUNDED CORNERS

FINISHES:

TOP: FENIX BLACK 109

BASE: POWDER-COATED MATT BLACK

APPROVAL: _____

SIGNATURE: _____

CROSSOVER
consultants



TAG: T7-B

BACK ◀

DWR RELATE SIDE TABLE

MODEL NO: 100184815
W 13.39" x D 22.13" x H 23.82"
QTY 1



PRODUCT DETAILS

MANUFACTURER: DWR
PRODUCT: RELATE SIDE TABLE
DESCRIPTION: SIDE TABLE WITH ROUNDED CORNERS

FINISHES:
TOP: PAINTED, BLACK
BASE: BLACK

APPROVAL: _____

SIGNATURE: _____



TAG: T7-C

BACK ◀

BERNHARDT QUIET TABLE

MODEL NO: QUS-228-BS-PLL-671

W 22" x D 22" x H 23.75"

QTY 1



PRODUCT DETAILS

MANUFACTURER: BERNHARDT

PRODUCT: QUIET SQUARE TABLE

DESCRIPTION: SQUARE OCCASIONAL TABLE WITH LAMINATE TOP AND STAINLESS BASE

FINISHES:

TOP: WHITE LAMINATE

BASE: BRUSHED STAINLESS STEEL

APPROVAL: _____

SIGNATURE: _____

CROSSOVER
consultants



TAG: T7-D

BACK ◀

BERNHARDT QUIET TABLE

MODEL NO: QUS-241-BS-PLL-671

W 21.25" x D 14 5/8" x H 23.75"

QTY 1



PRODUCT DETAILS

MANUFACTURER: BERNHARDT

PRODUCT: QUIET RECTANGULAR TABLE

DESCRIPTION: RECTANGULAR TAPERED LAPTOP TABLE

FINISHES:

TOP: WHITE LAMINATE

BASE: BRUSHED STAINLESS STEEL

APPROVAL: _____

SIGNATURE: _____



TAG: T5-A

BACK ◀

WATSON MIRO CONFERENCE TABLE

MODEL NO: MCCREC
DIMENSIONS DETERMINED ON LAYOUT
QTY 1



PRODUCT DETAILS

MANUFACTURER: WATSON
PRODUCT: MICRO CONFERENCE TABLE
DESCRIPTION: CUSTOM CONFERENCE TABLE WITH SPACE FOR ELECTRICAL OUTLETS OR CABLE TOWER. LAMINATE TOP WITH POWDER COATED LEGS

FINISHES:
TOP: BLACK LAMINATE
BASE & LEGS: BLACK

APPROVAL: _____

SIGNATURE: _____

CROSSOVER
consultants



TAG: T5-C

BACK ◀

WATSON TIA CONFERENCE TABLE

MODEL NO: ACTR
W 48" x L 48" x H "
QTY 1

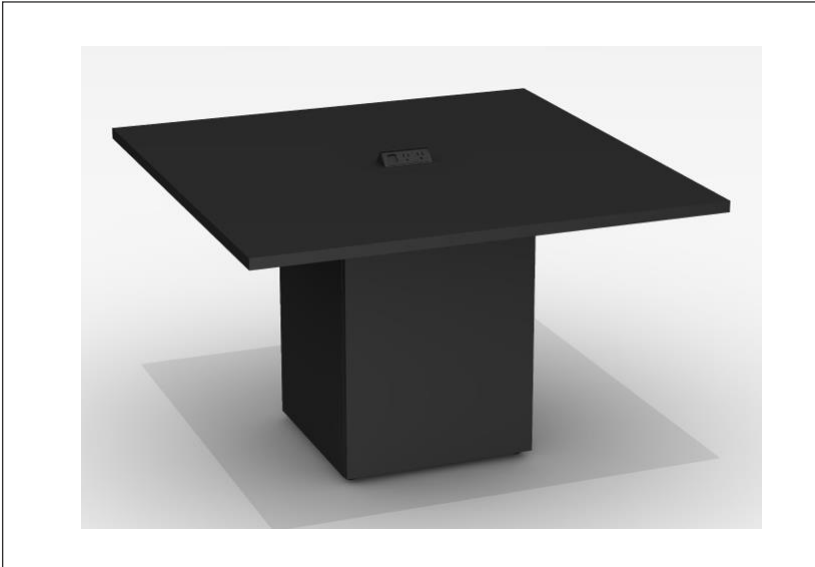

PRODUCT DETAILS

MANUFACTURER: WATSON
PRODUCT: TIA CONFERENCE TABLE
DESCRIPTION: TEAM CONFERENCE TABLE WITH ELECTRICAL ABILITY

FINISHES:
TOP: BLACK LAMINATE
BASE & LEGS: BLACK

APPROVAL: _____

SIGNATURE: _____



KIDS

CROSSOVER
consultants

TAG: K3-E

BACK ◀

DWR SOFTSQUARE POUF

MODEL NO: 100072475/100072474

W 18.5" x D 18.5" x H 16.5"

QTY 1



PRODUCT DETAILS

MANUFACTURER: SOFTLINE

PRODUCT: SOFTSQUARE POUF

DESCRIPTION: DWR SOFTSQUARE POUF

FINISHES:

SEAT/BACK: ANTHRACITE/LIGHT GREY

APPROVAL: _____

SIGNATURE: _____

TAG: K3-A

BACK ◀

VITRA ARTEK STOOL NE60

MODEL NO: 100162096/100117050

DIAM 15" x H 15"

QTY 1



PRODUCT DETAILS

MANUFACTURER: VITRA

PRODUCT: NE60 STOOL

DESCRIPTION: VITRA ARTEK NE60 CHILDRENS STOOL

FINISHES:

TOP: WHITE/BLACK

BASE: BIRCH

APPROVAL: _____

SIGNATURE: _____

TAG: K2

BACK ◀

VITRA ARTEK TABLE 90B

MODEL NO: 100162097/100125078

DIAM 29.5" x H 23.5"

QTY 1



PRODUCT DETAILS

MANUFACTURER: VITRA

PRODUCT: 90B TABLE

DESCRIPTION: VITRA ARTEK CHILDRENS TABLE 90B

FINISHES:

TOP: WHITE/BLACK

BASE: BIRCH

APPROVAL: _____

SIGNATURE: _____



STORAGE & ACCESSORIES

CROSSOVER
consultants

TAG: F7-A

BACK ◀

BOLON BOTANIC THYME RUG

MODEL NO: BNFLOATSBO
DIMENSIONS DETERMINED ON LAYOUT
QTY 1

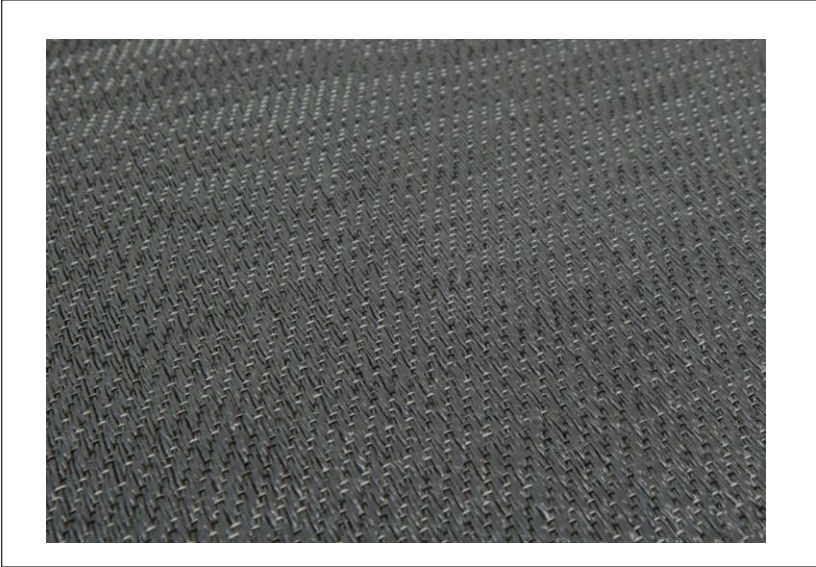

PRODUCT DETAILS

MANUFACTURER: BOLON
PRODUCT: BOTANIC THYME RUG
DESCRIPTION: SELF-BOUND SEAMED RUG FOR AUDI LOUNGE AREA

FINISHES:
COVERING: BOTANIC THYME FLOAT BESPOKE, SELF-BOUND SEAMED

APPROVAL: _____

SIGNATURE: _____

TAG: S1-F

BACK ◀

SPACESTOR PALISADES DIVIDER

MODEL NO: PGZ

DIMENSIONS DETERMINED ON LAYOUT

QTY 1



PRODUCT DETAILS

MANUFACTURER: SPACESTOR

PRODUCT: PALISADES STORAGE AND SPACE DIVIDER

DESCRIPTION: BASE UNIT, ALCOVE, SHEL & PANELS.CONFIGURATION DECIDED UPON SPACE

FINISHES:

APPROVAL: _____

SIGNATURE: _____



TAG: AP2-D, AP2-E, AP2-F

BACK ◀

MAGNUSON GROUP KASKAD PLANTERS

MODEL NO: KAS-0918S, KAS-0918M, KAS-0918H

S: W 18" x D 9" x H 12"

M: W 18" x D 9" x H 20"

L: W 18" x D 9" x H 36"

QTY 1



PRODUCT DETAILS

MANUFACTURER: MAGNUSON GROUP

PRODUCT: KASKAD PLANTERS, SMALL/MEDIUM/LARGE

DESCRIPTION: PAINTED STEEL RECTANGULAR PLANTER WITH LINER AND ADJUSTABLE GLIDES

FINISHES:

BASE: TEXTURED BLACK

APPROVAL: _____

SIGNATURE: _____



TAG: AP2-G

BACK ◀

POTS AND PLANTERS

MODEL NO: 69729-MBK

W 48" x D 10" x H 32"

QTY 1



PRODUCT DETAILS

MANUFACTURER: POTS & PLANTERS

PRODUCT: AMESBURY

DESCRIPTION: LOW GLOSS, INFINITY BLACK FIBERGLASS PLANTER

FINISHES:

INFINITY BLACK

APPROVAL: _____

SIGNATURE: _____



TAG: AP2-H

BACK ◀

POTS AND PLANTERS

MODEL NO: 69345-MBK

L 72" x D 16" x H 32"

QTY 1



PRODUCT DETAILS

MANUFACTURER: POTS & PLANTERS

PRODUCT: POTSDAM

DESCRIPTION: LOW GLOSS, INFINITY BLACK FIBERGLASS PLANTER

FINISHES:

INFINITY BLACK

APPROVAL: _____

SIGNATURE: _____

TAG: A7

BACK ◀

POPPIN DREAM DESK ACCESSORIES

MODEL NO:
DIMENSIONS DETERMINED ON ITEM
QTY 1



PRODUCT DETAILS

MANUFACTURER: POPPIN

PRODUCT: : DESK ACCESSORIES: BUSINESS CARD HOLDERS, LETTER TRAYS, STAPLER, TAPE, SOFT COVER NOTEBOOK, PEN CUP

DESCRIPTION: DARK GREY LACQUERED DESK ACCESSORIES

FINISHES:

FRAME: LACQUERED, DARK GREY

APPROVAL: _____

SIGNATURE: _____



TAG: A8

BACK ◀

MAGNUSON GROUP SILO UMBRELLA STAND

MODEL NO: SP-2550-SS

DIAM 9" x H 19"

QTY 1



PRODUCT DETAILS

MANUFACTURER: MAGNUSON GROUP

PRODUCT: SILO UMBRELLA STAND

DESCRIPTION: STAINLESS STEEL UMBRELLA STAND WITH DRIP TRAY

FINISHES:

EXTERIOR: BRUSHED STAINLESS STEEL

APPROVAL: _____

SIGNATURE: _____



TAG: A9-A

BACK ◀

ERGOTRON DUAL MONITOR ARMS

MODEL NO: 45-245-026

W 21.25" x D 14 5/8" x H 23.75"

QTY 1



PRODUCT DETAILS

MANUFACTURER: ERGOTRON

PRODUCT: LX DUAL STACKING MONITOR ARMS

DESCRIPTION: MONITOR MOUNT FOR SIDE-BY-SIDE MONITOR USE

FINISHES:

APPROVAL: _____

SIGNATURE: _____



TAG: A10-A

BACK ◀

KWIKBOOST CHARGING STATION

MODEL NO:KB-M8TS-FS-Pro

W 18" x H 8"

QTY 1

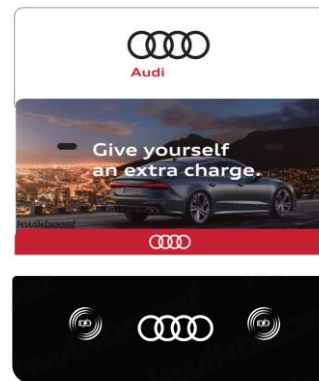
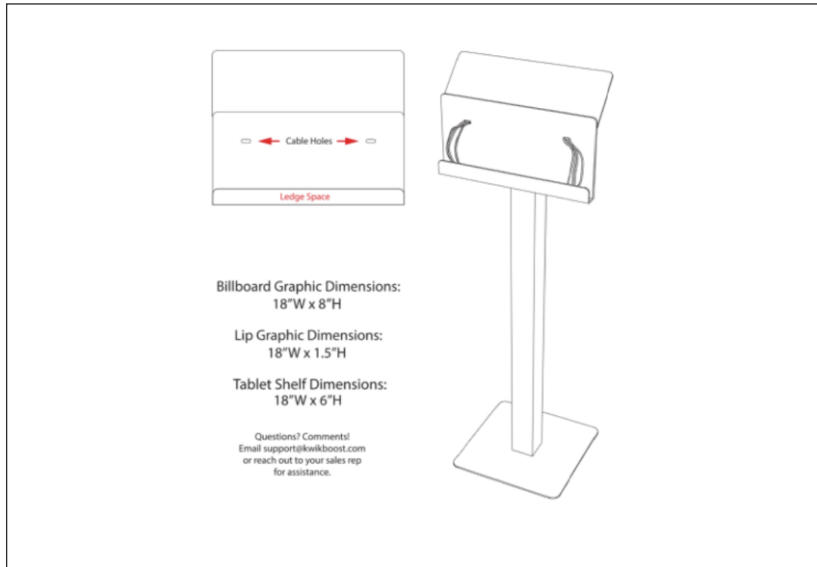

PRODUCT DETAILS

MANUFACTURER: KWIKBOOST

PRODUCT: CHARGING STATION

DESCRIPTION: FREESTANDING CHARGING STATION WITH TABLET STATION AND CUSTOM GRAPHICS

FINISHES:

FRAME: PC METALLIC GREY

APPROVAL: _____

SIGNATURE: _____

CROSSOVER
consultants

TAG: A10-C

BACK ◀

CHARGESPOT BUILT-IN WIRELESS CHARGING

MODEL NO: TX01002

DIMENSIONS DETERMINED ON LAYOUT

QTY 1

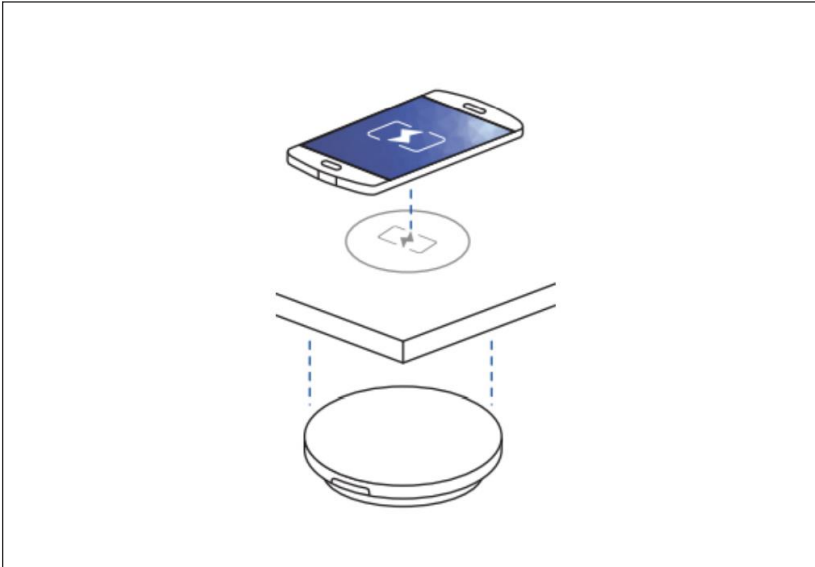

PRODUCT DETAILS

MANUFACTURER: CHARGESPOT

PRODUCT: CHARGING IN MILLWORK

DESCRIPTION: WIRELESS CHARGING SPOT BUILT-IN TO MILLWORK

FINISHES:

THIS PRODUCT IS HIDDEN IN DESK.

APPROVAL: _____

SIGNATURE: _____



OUTDOOR

CROSSOVER
consultants

TAG: EX-L1-A

BACK ◀

JANUS ET CIE SCOOP LOUNGE CHAIR

MODEL NO: 752-01-011-81-00
W 25.5" x D 25.5" x H 27.5" x SH 15.75"
QTY 1



PRODUCT DETAILS

MANUFACTURER: JANUS ET CIE
PRODUCT: SCOOP LOUNGE CHAIR
DESCRIPTION: OUTDOOR CHAIR WITH ROUNDED FEATURES

FINISHES:
SEAT & FRAME: MATTE ANTHRACITE

APPROVAL: _____

SIGNATURE: _____



TAG: EX-L15-A

BACK ◀

ANDREU WORLD TRENZA LOUNGE CHAIR

MODEL NO: BU0702

W 26.5" x D 26.5" x H 28" x SH 15.75"

QTY 1



PRODUCT DETAILS

MANUFACTURER: ANDREU WORLD

PRODUCT: TRENZA LOUNGE CHAIR

DESCRIPTION: OUTDOOR LOUNGE CHAIR WITH STEEL FRAME

FINISHES:

SEAT: WOVEN GRAPHITE

FRAME: STEEL

APPROVAL: _____

SIGNATURE: _____



TAG: EX-L15-B

BACK ◀

JANUS ET CIE ROXY ARMCHAIR

MODEL NO: 776-03-011-80-00
W 27" x D 25.5" x H 33" x SH 18"
QTY 1



PRODUCT DETAILS

MANUFACTURER: JANUS ET CIE

PRODUCT: ROXY ARMCHAIR

DESCRIPTION: OUTDOOR DINING/LOUNGE CHAIR WITH ALUMINUM FRAME AND SYNTHETIC FIBER SEAT

FINISHES:

SEAT: SYNTHETIC FIBER, NERO

FRAME: POWDER COATED ALUMINUM

APPROVAL: _____

SIGNATURE: _____

CROSSOVER
consultants



TAG: EX-L1-B

BACK ◀

HARBOUR OUTDOOR HAYMAN ARMCHAIR

MODEL NO: HAYM-08A-CUSTOM

W 39.4" x D 33.5" x H 22.4"

QTY 1



PRODUCT DETAILS

MANUFACTURER: HARBOUR OUTDOOR

PRODUCT: HAYMAN ARMCHAIR

DESCRIPTION: LOUNGE CHAIR WITH ALUMINUM POWDER COATED FRAME AND BATYLINE SEAT CONSTRUCTION FOR EXTRA COMFORT. ELEMENT-RESISTANT FABRIC

FINISHES:

FRAME: ALUMINUM ASTEROID

SEAT: CAST SLATE

APPROVAL: _____

SIGNATURE: _____

CROSSOVER
consultants



TAG: EX-CH6-A

BACK ◀

HARBOUR OUTDOOR PIANO DINING CHAIR

MODEL NO: PIAN-01A-ALAST-BASIL
W 22.83" x D 23.62" x H 33.27" x SH 17.32"
QTY 1



PRODUCT DETAILS

MANUFACTURER: HARBOUR OUTDOOR

PRODUCT: PIANO DINING CHAIR

DESCRIPTION: DINING CHAIR WITH POWDER-COATED ALUMINUM BASE AND BATYLINE MESH

FINISHES:

FRAME: ALUMINUM ASTEROID

SEAT: BATYLINE SILVER MESH

APPROVAL: _____

SIGNATURE: _____

CROSSOVER
consultants



TAG: EX-L10-A

BACK ◀

JANUS ET CIE MATISSE SOFA

MODEL NO: 704-95-401-81-81
W 25.5" x D 25.5" x H 27.5" x SH 15.75"
QTY 1

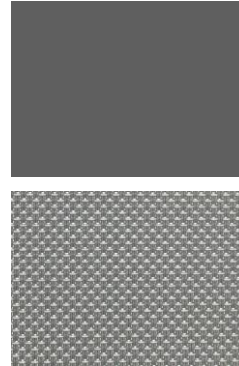

PRODUCT DETAILS

MANUFACTURER: JANUS ET CIE
PRODUCT: MATISSE 2-SEAT SOFA
DESCRIPTION: OUTDOOR SOFA WITH ALUMINUM BASE AND CUSHIONS

FINISHES:
FRAME & SEAT: GRAPHITE/STARLIGHT

APPROVAL: _____

SIGNATURE: _____



TAG: EX-L10-B

BACK ◀

ANDREU WORLD SIESTA SOFA

MODEL NO: SF4750, SF4751, SF4755
W 63" x D 31.5" x H 29.25" x SH 16.5"
QTY 1

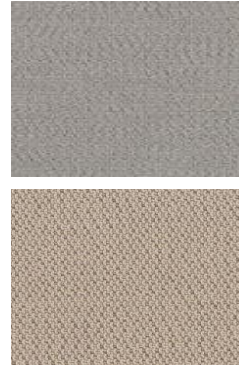

PRODUCT DETAILS

MANUFACTURER: ANDREU WORLD

PRODUCT: SIESTA SOFA

DESCRIPTION: OUTDOOR MODULAR SOFA, UPHOLSTERED SEAT AND BACKREST WITH STEEL SLED BASE

FINISHES:

SEAT CUSHIONS: SUNBRELLA, LOPI SILVER/LOPI SAND

FRAME: EARTH BROWN OR WHITE

APPROVAL: _____

SIGNATURE: _____

CROSSOVER
consultants



TAG: EX-T6-A

BACK ◀

JANUS ET CIE BELL SIDE TABLE

MODEL NO: 752-01-611-81-00

DIAM 20.5" x H 19.75"

QTY 1



PRODUCT DETAILS

MANUFACTURER: JANUS ET CIE

PRODUCT: BELL SIDE TABLE ROUND 52

DESCRIPTION: POLYETHYLENE SIDE TABLE WITH ROUNDED EDGE BASE

FINISHES:

FRAME: MATTE ANTHRACITE

APPROVAL: _____

SIGNATURE: _____

CROSSOVER
consultants



TAG: EX-T2-A

BACK ◀

ANDREU WORLD COMPACTO TOP WITH DUAL BASE

MODEL NO: SB4570, BM4361

W 23.75" x D 23.75" x H 28.5"

QTY 1



PRODUCT DETAILS

MANUFACTURER: ANDREU WORLD

PRODUCT: COMPACTO TABLE WITH DUAL BASE

DESCRIPTION: SQUARE COMPACT TABLETOP WITH ROUND BASE

FINISHES:

FRAME: HPL, WHITE OR BLACK

APPROVAL: _____

SIGNATURE: _____

TAG: EX-T1-B

BACK ◀

ANDREU WORLD SIESTA OUTDOOR TABLE

MODEL NO: ME4753

W 31.5" x L 31.5"

QTY 1



PRODUCT DETAILS

MANUFACTURER: ANDREU WORLD

PRODUCT: SIESTA OUTDOOR TABLE

DESCRIPTION: OCCASIONAL TABLE WITH STEEL SLED BASE AND STEEL SHEET TOP

FINISHES:

FRAME: EARTH BROWN OR WHITE

APPROVAL: _____

SIGNATURE: _____



TAG: EX-T1-A

BACK ◀

ANDREU WORLD COMPACTO TOP WITH QUATTRO BASE

MODEL NO: SB4582, BM4721

DIAM 31.5" x H 16"

QTY 1



PRODUCT DETAILS

MANUFACTURER: ANDREU WORLD

PRODUCT: COMPACTO TOP WITH QUATTRO 70 BASE

DESCRIPTION: ROUND TABLE WITH CENTRAL 4-STAR BASE IN MATTE FINISH

FINISHES:

FRAME: WHITE OR BLACK

TOP: HPL, WHITE OR BLACK

APPROVAL: _____

SIGNATURE: _____

CROSSOVER
consultants

TAG: EX-T6-B

BACK ◀

HARBOUR OUTDOOR HAYMAN SIDE TABLE

MODEL NO: HAYM-11B-ALAST
W 22.83" x D 24.02" x H 18.11"
QTY 1

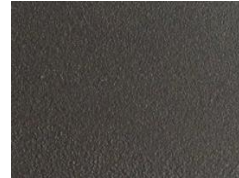

PRODUCT DETAILS

MANUFACTURER: HARBOUR OUTDOOR
PRODUCT: HAYMAN SIDE TABLE
DESCRIPTION: SQUARE SIDE TABLE WITH SLATS

FINISHES:
FRAME: ALUMINUM ASTEROID

APPROVAL: _____

SIGNATURE: _____

TAG: EX-T2-B

BACK 

HARBOUR OUTDOOR PIANO PEDESTAL TABLE

MODEL NO: PIAN-03F-CUSTOM

DIAM 30" x H 29"

QTY 1



PRODUCT DETAILS

MANUFACTURER: HARBOUR OUTDOOR

PRODUCT: PIANO PEDESTAL TABLE

DESCRIPTION: ROUND ALUMINUM POWDER-COATED PEDESTAL TOPPED WITH SYNTHETIC TEAK

FINISHES:

FRAME: ALUMINUM ASTEROID

TOP: SYNTEAK GREY OR HPCL, WHITE

APPROVAL: _____

SIGNATURE: _____

CROSSOVER
consultants

TAG: EX-T2-C

BACK ◀

HARBOUR OUTDOOR HAYMAN DINING TABLE

MODEL NO: PIAN-03C-CUSTOM

W 105.5" x D 39.4" x H 29.33"

QTY 1



PRODUCT DETAILS

MANUFACTURER: HARBOUR OUTDOOR

PRODUCT: HAYMAN DINING TABLE

DESCRIPTION: POWDER-COATED ALUMINUM BASE WITH SLATTED, SYNTHETIC WOOD TABLETOP

FINISHES:

FRAME: ALUMINUM ASTEROID

SEAT: SYNTEAK GREY OR HPCL, WHITE

APPROVAL: _____

SIGNATURE: _____

LIGHTING





TAG: TL1-D

BACK ◀

FLOS SPUN LIGHT

MODEL NO: FU661030

W 10.5" x H 10.5" x DIAM 15"

QTY 1



PRODUCT DETAILS

MANUFACTURER: FLOS

PRODUCT: SPUN LIGHT T

DESCRIPTION: TABLE LAMP WITH SPUN METAL FRAME AND ALUMINUM DIFFUSER SUPPORT FROSTED HALOGEN BULB

FINISHES:

FRAME: SHINY BLACK

APPROVAL: _____

SIGNATURE: _____

CROSSOVER
consultants



TAG: TL1-F

BACK ◀

PABLO LIM LAMP

MODEL NO: LIM L TBL SLV BR

L 28" x H 12" - 18"

QTY 1

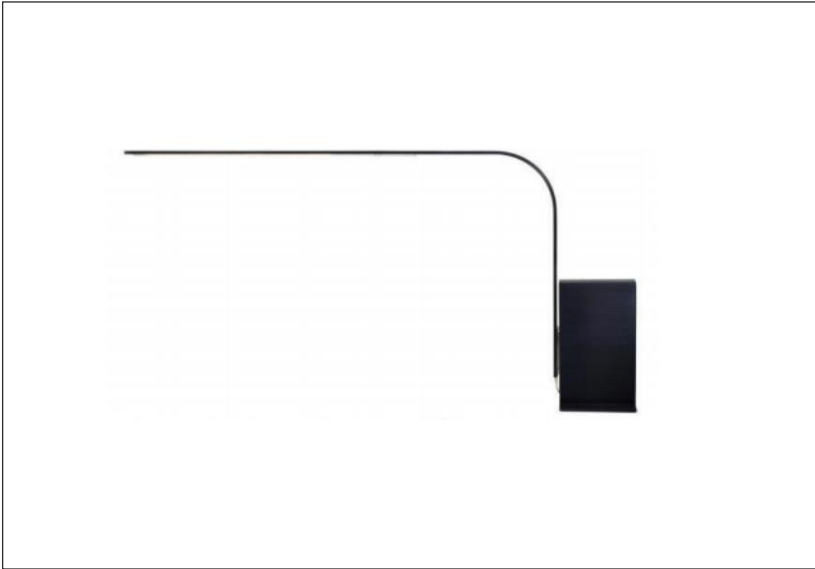

PRODUCT DETAILS

MANUFACTURER: PABLO

PRODUCT: LIM DESK/TABLE LAMP

DESCRIPTION: ALUMINUM DESK LAMP WITH ALUMINUM AND STEEL TABLE BASE. MAGNETIC ATTACHMENT, LED ARRAY ELIMINATES MULTIPLE SHADOWS. FULL RANGE DIM CONTROL

FINISHES:

FRAME: BRUSHED SILVER/BLACK

APPROVAL: _____

SIGNATURE: _____

CROSSOVER
consultants



TAG: TL1-G

BACK ◀

PABLO PIXO LAMP

MODEL NO: PIXO
W 5" x L 6" x H 16.5"
QTY 1



PRODUCT DETAILS

MANUFACTURER: PABLO
PRODUCT: PIXO DESK/TABLE LAMP
DESCRIPTION: ALUMINUM ARM TABLE LAMP. ARM ROTATION AND TILT, USB CHARGING PORT, LED LIGHT, FULL RANGE DIM CONTROL

FINISHES:
FRAME: GRAPHITE

APPROVAL: _____

SIGNATURE: _____



TAG: TL1-H

BACK <

PABLO TUBE TOP LAMP

MODEL NO: HCPL-TTT1-14, HCPL-TTT1-21

S: W 9.5" x D 4.5" x H 14"

M: W 15" x D 6.5" x H 21"

QTY 1



PRODUCT DETAILS

MANUFACTURER: PABLO

PRODUCT: TUBE TOP LAMP

DESCRIPTION: POLYESTER MESH SHADE, ACRYLIC BODY, FABRIC CORD, FULL RANGE DIM CONTROL

FINISHES:

BODY & SHADE: CHARCOAL

APPROVAL: _____

SIGNATURE: _____

CROSSOVER
consultants



TAG:

BACK ◀

TWIGGY FLOOR LAMP

MODEL NO: FOS542941
W 105.5" x D 39.4" x H 29.33"
QTY 1



PRODUCT DETAILS

MANUFACTURER: Y LIGHTING

PRODUCT: TWIGGY FLOOR LAMP

DESCRIPTION: COATED FIBERGLASS-BASED COMPOSITE MATERIAL. CURVED FLOOR LAMP WITH BLACK SHADE. FULL RANGE DIM CONTROL

FINISHES:

FRAME: BLACK

APPROVAL: _____

SIGNATURE: _____

CROSSOVER
consultants

TAG: FL1-B

BACK ◀

FLOS SPUN FLOOR LAMP

MODEL NO:

H 69.5" x DIAM 19.7"

QTY 1



PRODUCT DETAILS

MANUFACTURER: FLOS

PRODUCT: SPUN LIGHT T FLOOR LAMP

DESCRIPTION: FLOOR LAMP WITH SPUN METAL FRAME AND ALUMINUM DIFFUSER SUPPORT.
FROSTED INCADENDESCENT BULB

FINISHES:

FRAME: SHINY WHITE/SHINY BLACK

APPROVAL: _____

SIGNATURE: _____



TAG: CPL1-A

BACK ◀

DWR CIRCA PENDANT

MODEL NO: 100078311
DIAM 16" – DROP MAX 120"
QTY 1



PRODUCT DETAILS

MANUFACTURER: DWR
PRODUCT: CIRCA PENDANT
DESCRIPTION: 3 GRAPHITE PENDANTS, PLACED EVENLY ABOVE BAR HEIGHT

FINISHES:
FRAME: GRAPHITE

APPROVAL: _____

SIGNATURE: _____



TAG: CPL1-B

BACK ◀

PABLO CIELO PENDANT

MODEL NO: CIEL HB BLK/BLK/BLK

DIAM 6" x D 9" – DROP MAX 120"

QTY 1



PRODUCT DETAILS

MANUFACTURER: PABLO

PRODUCT: CIELO

DESCRIPTION: ALUMINUM BODY, POLYCARBONATE LENS, ABS CANOPY, FABRIC CORD. ENERGY-EFFICIENT, FLAT-PANEL TECHNOLOGY, FULLY DIMMABLE LIGHT SOURCE, GLARE-FREE ILLUMINATION

FINISHES:

FRAME: BLACK

APPROVAL: _____

SIGNATURE: _____

CROSSOVER
consultants



TAG: CPL1-C

BACK ◀

SELUX M60

MODEL NO: L6DI
DIRECT/INDIRECT H 4.75"
QTY 1



PRODUCT DETAILS

MANUFACTURER: SELUX

PRODUCT: M60

DESCRIPTION: MOUNTED PENDANT WITH LOW COPPER ALUMINUM HOUSING AND DIE CAST ENDCAPS, LED OPTIMIZED

FINISHES:

FRAME: TIGER DRYLAC CERTIFIED POLYESTER POWDER COAT FINISH

APPROVAL: _____

SIGNATURE: _____

CROSSOVER
consultants



TAG: CPL1-D

BACK ◀

STICKBULB 8' PENDANT

MODEL NO: PEND-8FT

W 5.5" x D 1.5" x L 8'

QTY 1

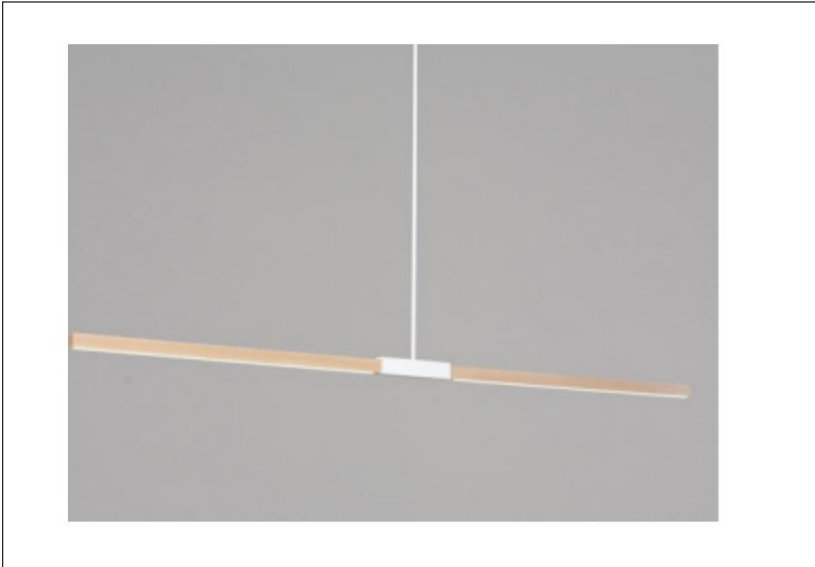

PRODUCT DETAILS

MANUFACTURER: STICKBULB

PRODUCT: 8' PENDANT

DESCRIPTION: LINEAR PENDANT -BULBS CAN BE ORIENTED TO PROVIDE DOWNLIGHT OR UPLIGHT-
WALNUT OR POWDER COATED MATTE BLACK STEEL

FINISHES:

FRAME: MATTE BLACK STEEL

APPROVAL: _____

SIGNATURE: _____

CROSSOVER
consultants



TAG: CPL1-E

BACK ◀

STICKBULB MULTI PENDANTS

MODEL NO: MULT-PEND-10FTFINISHES

L 10' – DROP MAX 60"

QTY 1



PRODUCT DETAILS

MANUFACTURER: STICKBULB

PRODUCT: MULTI PENDANTS 10FT

DESCRIPTION: LINEAR PENDANTS CAN BE GROUPED WITH (3) FIXTURES IN A SHARED CANOPY -
BULBS CAN BE ORIENTED TO PROVIDE DOWNLIGHT OR UPLIGHT-WALNUT OR POWDER COATED
MATTE BLACK STEEL

FINISHES:

FRAME: MATTE BLACK STEEL

APPROVAL: _____

SIGNATURE: _____

CROSSOVER
consultants



TAG: CPL1-F

BACK ◀

STICKBULB SKY BANG PENDANT

MODEL NO: BIG-SKBNG
L 120" x W 28.5" x H 22.5"
QTY 1



PRODUCT DETAILS

MANUFACTURER: STICKBULB

PRODUCT: SKY BANG

DESCRIPTION: HOLDS 6 BULBS OF DIFFERENT LENGTHS-BULBS CAN BE ORIENTED TO PROVIDE DOWNLIGHT OR UPLIGHT-WALNUT OR POWDER COATED MATTE BLACK STEEL

FINISHES:

FRAME: POWDER-COATED MATTE BLACK

APPROVAL: _____

SIGNATURE: _____

CROSSOVER
consultants



TAG: CPL1-G

BACK ◀

PABLO BOLA PENDANT

MODEL NO: BOLA 12, BOLA 18, BOLA 22

DIAM 12", 18", or 22"

QTY 1



PRODUCT DETAILS

MANUFACTURER: PABLO

PRODUCT: BOLA PENDANT

DESCRIPTION: LED PENDANT WITH CHROMATED SIC REFLECTORS

FINISHES:

FRAME: CHROME/BRASS/ROSE GOLD/GUNMETAL/MATTE BLACK/GLOSS WHITE, CHROME

APPROVAL: _____

SIGNATURE: _____

CROSSOVER
consultants



TAG: CPL1-H

BACK ◀

LUCEPLAN SOLEIL NOIR PENDANT

MODEL NO: D89, 1D890S000535

W 47" x D 24.6" x H 13.8"

QTY 1



PRODUCT DETAILS

MANUFACTURER: LUCEPLAN LIGHTING

PRODUCT: SOLEIL NOIR

DESCRIPTION: SUSPENSION LED PENDANT WITH ORGANIC FOAM

FINISHES:

FRAME: MOLDED POLYURETHANE FOAM, BLACK

APPROVAL: _____

SIGNATURE: _____

CROSSOVER
consultants



CONTACT US

crossoverconsultants.com

Sheri David | sdavid@crossover-consultants.com | 917.608.5669

Nicole Zaretsky | nzaretsky@crossover-consultants.com | 516.382.5112

CROSSOVER
consultants